

TOSHIBA

WirelessIP 5000 User's Manual

Thank you for purchasing the WirelessIP 5000.

- Please carefully read and understand this "User's Manual" before using the product.
- After reading this manual, please keep it close at hand for use any time you need it.

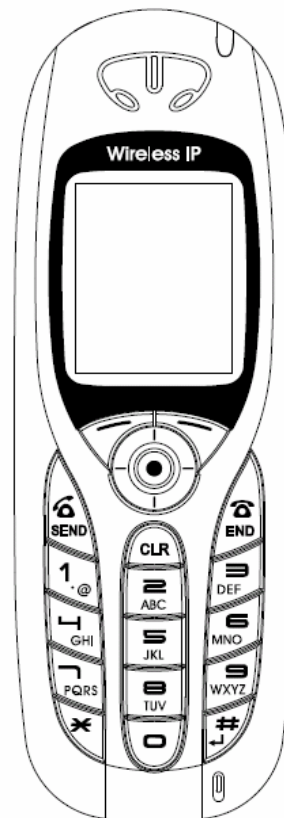





Product certified to meet technical standards

Introduction

Thank you for your purchase of this product.

This user's manual contains items that you should follow in order to prevent any harm to yourself and others, or damage to equipment, and to enable you to use this product safely. An explanation of the markings and symbols used in this manual is provided below. Please understand these symbols before reading the rest of this document.

Please always observe for the sake of safety.

 Warning	This symbol indicates details that if ignored, and the product is handled incorrectly, can result in death or severe injury.
 Caution	This symbol indicates details that if ignored, and the product is handled incorrectly, can result in injury or damage to equipment.
 STOP	This symbol indicates details that if ignored, and the product is handled incorrectly, can result in failure of this product to perform to its full capacity or in loss of function.
 Notice	This symbol indicates cautions concerning the handling of this product.

- Every care has been taken in the writing of this manual, but if you find any points of concern with this manual, please notify us through one of our contact points.
- Please understand that this company can not assume any responsibility for any damage or other pure economic loss resulting from lost communications opportunities due to a breakdown of this product, its incorrect operation, power failure or other external factors.
- After sales service

We request that you write down in a memo or otherwise store any information that you yourself have registered in this product.

This company has no obligation concerning changes to, or loss of, any information and bears no responsibility for this whatsoever.

During repairs for a breakdown, data created by the customer or loaded in from outside may change or be lost.

This company takes no responsibility for this.

Introduction

■ Registered trademarks/copyrights

- Windows is a registered trademark of the Microsoft Corporation in the United States and other countries.
- Windows XP is an abbreviation for the Microsoft Windows XP Home Edition operating system and the Microsoft Windows XP Professional operating system.
- Windows 2000 is an abbreviation for the Microsoft Windows 2000 Professional operating system.
- The Japanese-language converter software "Mini-Wnn" is a registered trademark of Omron Software, Ltd.
- Other company names and product names are trademarks or registered trademarks of their respective companies.

Any reproduction or copying of its content without prior permission is strictly forbidden.

The contents of this manual may be revised at any time without prior notice. For support information about added functions, changes, etc., we recommend that you periodically visit the home page below for updated information.

Our company's home page <http://www.wirelessip5000.com/>

■ Voluntary Control Council for Interference by Information Technology Equipment (VCCI) standards

This device is a Class B Information Technology Device as defined by the Voluntary Control Council for Interference by Information Technology Equipment (VCCI). This product is intended for use in home environments, but if it is used near radio or TV receivers, it may cause interference with reception. Please use this product correctly as explained in this user's manual.

■ Caution concerning the Radio Law and wireless LAN

The wireless device used in this product has received special wireless device certification as a low-power data communications system wireless device based on the Radio Law. Therefore, use of this product does not require any wireless station permit.

- Use of this product is restricted to within Japan. This product was designed and manufactured for use within Japan. Therefore, using this product outside of Japan may break this product and other equipment. Such usage may also touch on the laws of that nation, so this product may not be used outside of Japan.
- Do not use this product near persons using pacemakers. This product may cause life-threatening electromagnetic interference with a cardiac pacemaker.
- Do not use this product near medical equipment. This product may cause life-threatening electromagnetic interference with medical equipment.
- Do not use this product near a microwave oven that is in use. A microwave oven can cause electromagnetic interference with the wireless communications of this product.
- The wireless device in this product has been certified under the Radio Law, so do not disassemble or alter this product.

Introduction

■ Caution concerning interference with 2.4GHz wireless LAN

When communicating with a 2.4GHz LAN, be careful about the following.

Microwave ovens and other industrial, scientific, and medical equipment, as well as indoor wireless stations (wireless stations requiring permits) and special low-power wireless stations (wireless stations not requiring permits) used for identifying mobile units used in plant manufacturing line etc., as well as amateur wireless stations (wireless stations requiring permits) operate in the frequency band used by this product.

- Before using this product, double check that no indoor wireless stations, special low-power wireless stations for mobile unit identification, or amateur wireless stations are in operation in the vicinity.
- If this product should cause harmful electromagnetic interference in an indoor wireless station for identifying a mobile unit, quickly change the frequency used or stop emitting the electromagnetic signal, then notify the store of purchase and consult with them about measures for avoiding interference (for example, installing a partition wall).
- Besides that, if this product should cause harmful electromagnetic interference in a special low-power wireless station used for identifying a mobile unit, or in an amateur wireless station, or some other problem occurs, please inquire at the store from which you made your purchase.

■ Built-in 2.4GHz band (IEEE801.11b) wireless LAN functions

Usage frequency band : Wireless equipment using the 2.4GHz band

Transmission method : DSSS

Modulation : DQPSK DBPSK CCK

Assumed interference distance : 40 m max.

Frequency modulation advantages : The entire bandwidth can be used to avoid the frequency bands of indoor wireless stations and special low-power wireless stations used for identifying mobile units, as well as amateur wireless stations.

Because the 2.4GHz band frequency used in this product overlaps with medical equipment, microwave ovens and other industrial and scientific equipment, as well as indoor wireless stations and special low-power wireless stations for identifying mobile units used in plant manufacturing line etc., electromagnetic interference is possible. Before starting to use this product, double check that no indoor wireless stations or special low-power wireless stations are operating within the interference range of this product.

Safety precautions

Be sure to read this section for the sake of safe usage. Please observe these precautions in order to use this product safely and prevent injury to the user and others and to prevent damage to equipment.

Please understand these "warnings" and "cautions" before reading the rest of this manual.

Store it safely near at hand for future reference after reading it.

The phone



Warning

- **Do not use any AC adaptor other than the one came with this product.**
Doing so can result in fire, electrical shock, and malfunction.
- **Do not use any accessory or separately-sold item other than those specified for this product.**
Doing so can result in fire, electrical shock, and malfunction.
- **Never swing or throw this product by the end of a hand-strap (off-the-shelf product).**
You could strike and hurt someone or damage this product.
- **This device should not, under any circumstances, be used inside an airplane or aviation facilities, a high-speed train (bullet train) or a hospital.**
Electromagnetic interference could cause electronic equipment to malfunction and result in an accident.
- **Do not use this product with wet hands.**
This can result in electrical shock.
- **Never use this product in any location where it can be easily wet by water or other liquid (such as near a sink or hot tub).**
- **Never disassemble or alter this product. Do not repair this product yourself**
Doing so can result in fire, electrical shock, and malfunction.
- **Use this product somewhere out of the reach of infants and small children.**
An infant or small child playing with this product could receive an electrical shock and injury.
- **Please discontinue use if any unusual conditions should occur, such as the device emitting smoke, an unusual smell, a strange noise, or water getting into this product.**
Continued use the device in this condition can result in the outbreak of fire, electric shock, or malfunction. Immediately cut off the power and remove the battery pack. Make sure that the smoke stops, then contact the store of purchase.

Safety precautions



Caution

- **Do not install the device on shaky, inclined, or otherwise unstable surfaces.**
The product might fall and cause a fire, injury, or breakdown.
- **Do not sit on this product, place a heavy object on it, or pinch it between objects.**
Doing so may break this product
- **Do not use this product where dew condensation may occur.**
When moving this product suddenly between environments at drastically different temperatures, there is a danger of dew condensation, so take care. This can cause deformation, discoloration, fire, and breakdown. If dew condensation forms in this product, either dry it or leave it for a long while in the current environment before using it.
- **Do not leave this product anywhere subject to drastic environmental changes, such as locations subject to direct sunlight or near a heater or air conditioner.**
This can cause deformation, discoloration, fire, and breakdown.
- **Do not drop the product or subject it to strong shocks.**
Doing so may cause injury or breakdown.
- **Do not use or leave this product in any location subject to high humidity or dust.**
Doing so may break this product
- **Do not use this product near a radio or television.**
It may cause or be subject to electromagnetic interference.
- **Do not use this product in strong magnetic fields or where static electricity occurs or where the temperature or humidity exceeds the usage environment given in the user's manual.**
Doing so may break this product
- **Never use paint thinner or benzine to clean this product.**
This can cause deterioration of the case or paint peeling. Normally, wipe this product with a soft cloth. If it is quite dirty, dip the cloth in a little diluted neutral detergent.

Safety precautions

Battery pack (accessories)



Warning

- **Failure to follow the items below can cause rupture, fire, heat, battery fluid leakage, electrical shock, and burns.**
 - Do not charge the battery pack with any method other than that specified.
 - Do not use this battery pack in any device other than this product.
 - Do not put this product into fire or heat it.
 - Do not solder this product.
 - Do not carry or leave this product with a necklace or other metal.
 - Do not short the terminals of the battery pack.
 - Do not use, charge, or leave near an open fire, near a stove, subject to direct sunlight, or anywhere else that reaches high temperatures.
 - If any fluid that has leaked from the battery gets in your eyes, do not rub them. There is a danger of blindness, so immediately wash out your eyes with plenty of clean water and seek immediate medical attention.
 - Use only the battery pack specifically manufactured for the Hitachi Cable WirelessIP 5000. Using a product not designed for the WirelessIP 5000 would cause danger and would make it impossible to warranty the correct operations of this product and your communications.
- **Failure to follow the items below can cause rupture, heat, and battery fluid leakage.**
 - Do not wrap this battery pack with tape or otherwise process it. This battery pack may emit gas.
 - Do not attempt to disassemble or alter the battery pack.
 - Do not place any tool or other metal or electrically conductive item on the battery pack or let such item fall onto the battery pack.
 - Keep water and seawater off and out of the battery pack.



Caution

- **Failure to follow the items below can cause rupture, heat, battery fluid leakage, rust, and impaired performance and reduced service life.**
 - Do not charge the battery pack longer than the specified time.
 - Only charge the battery pack within the ranges of 0-40°C and 10-90% humidity.
 - Do not use or store in any location that can reach high temperature.
 - Do not charge outdoors in the cold or use while cold.
 - Do not throw this battery pack or subject it to strong mechanical shock.
 - Always switch the power switch Off when the product is not in use.
 - When this product will be left unused for a prolonged period, remove the battery pack and store it in a dry location at a temperature between 0 and 25°C.
- **Never use paint thinner or benzine to clean this product.**

This can cause deterioration of the case or paint peeling. Normally, wipe this product with a soft cloth. If it is quite dirty, dip the cloth in a little diluted neutral detergent.

Safety precautions

AC adaptor (accessory)



Warning

- **Failure to follow the items below can cause rupture, fire, heat, battery fluid leakage, electrical shock, burns, and breakdown.**
 - This device should not be used at a voltage other than 100 VAC.
 - Do not charge the battery pack with any method other than that specified.
 - Do not use this battery pack in any device other than this product.
 - Do not use any AC adaptor other than the one came with this product.
 - Do not use this AC adaptor to charge anything other than the battery pack that came with this product.
 - Do not attempt to disassemble or alter the battery pack. Do not repair this product yourself
 - Use only an AC adaptor specifically manufactured for the Hitachi Cable WirelessIP 5000. Using a product not designed for the WirelessIP 5000 would cause danger and would make it impossible to warranty the correct operations of this product and your communications.

- **Failure to follow the items below can cause fire, heat, electrical shock, injury, and breakdown.**
 - Do not let water get into or onto the AC adaptor. Do not use the AC adaptor with wet hands.
 - Do not under any circumstances touch the AC adaptor with wet hands during charging.
 - Do not place any heavy object on the power cord or pinch it between objects.
 - Use this product somewhere out of the reach of infants and small children.
 - Plug the AC adaptor all the way into the electrical socket.
 - Plug the AC adaptor into its own socket, not into a multi-socket tap or extension cord.
 - Check that the power plug (or AC adaptor) is free from dust before plugging into the electrical socket. Once every six months to one year, unplug the power plug (or AC adaptor) from the socket and inspect and clean it. Dust build up could cause fire and electrical shock.
 - When plugging or unplugging the AC adaptor, always hold the adaptor itself, not the cord.
 - When unplugging or plugging in the power cord, hold it by the plug. Never pull the cord itself.
 - Do not process the power supply cord, bend or twist it with excessive force, yank it, or heat it.
 - If the power supply cord is damaged or the plug is loose in the socket, do not use the AC adaptor.
 - If there is lightning in the vicinity, for safety sake, unplug from the socket.
 - Please discontinue use if any unusual conditions should occur, such as the device emitting smoke, an unusual smell, or a strange noise. If such a condition should occur, immediately disconnect the AC adaptor from the electrical socket, make sure that the smoke stops, then contact the store of purchase.

Safety precautions



Caution

- **Failure to follow the items below can cause fire, battery fluid leaks, heat, electrical shock, and injury.**
 - After charging is complete and when not charging, unplug the AC adaptor from the electrical socket.
 - Only charge the battery pack within the ranges of 0-40° C and 10-90% humidity.
 - Do not use or leave this product in any location subject to high humidity or dust or poor ventilation.
 - When plugging or unplugging the AC adaptor, do not pull on the power cord.
- **Never use paint thinner or benzine to clean this product.**

This can cause deterioration of the case or paint peeling. Normally, wipe this product with a soft cloth. If it is quite dirty, dip the cloth in a little diluted neutral detergent.

CONTENTS

Introduction.....	2
Safety precautions.....	5
CONTENTS.....	10
Chapter 1 Overview	1-1
Features of the WirelessIP	1-2
Names & Functions of Device Parts	1-4
Using accessories	1-7
Accessories.....	1-7
Battery pack installation method	1-7
Using accessories	1-8
Battery pack removal	1-8
AC power supply adaptor.....	1-8
Charging method.....	1-9
Chapter 2 Placing and Receiving Telephone Calls	2-1
Switching the Power On/Off	2-2
Power ON.....	2-2
Power OFF	2-2
Calling method.....	2-3
Receiving calls.....	2-4
Call log.....	2-5
Details	2-6
Deleting one item from the call log.....	2-7
Deleting the entire call log.....	2-8
Various operation methods.....	2-9
Redial	2-9
Calling from the call log.....	2-9
Call from phone book.....	2-10
Caller ID	2-12
Speed Dialing.....	2-13
Hold function	2-14
Call waiting.....	2-15
Hold transfer.....	2-16
Chapter 3 Phone book.....	3-1
Phone book menu	3-2
Phone book registration.....	3-3
Registration from phone book menu	3-3
Registration from a telephone number.....	3-5
Registration from a call log.....	3-7
Phone book editing.....	3-9
Phone book editing.....	3-10
Group management.....	3-11
Deleting one item from phone book.....	3-13
Deleting entire phone book.....	3-15
Chapter 4 Messaging.....	4-1
Message menu	4-2
Inbox.....	4-3
New Message.....	4-7
Drafts	4-8
Outbox.....	4-11
Setting	4-14
Chapter 5 Presence	5-1

Presence menu	5-2
User list.....	5-3
Block list	5-7
Status	5-11
Setting	5-12
Chapter 6 Other settings.....	6-1
Manner mode On/Off.....	6-2
Setting/Ending keylock	6-3
Settings menu.....	6-5
Password/lock mode selection	6-6
Ringer/vibrator	6-8
Alarm	6-9
Volume adjustment.....	6-10
Error Notification.....	6-11
Service LED	6-11
Error message.....	6-12
Error log	6-12
Information display	6-14
TCP/IP.....	6-14
Wireless networking	6-15
SIP	6-15
MAC address value.....	6-16
Web server.....	6-16
Version.....	6-17
Equipment settings	6-18
Time	6-18
Contrast.....	6-21
Font size.....	6-21
Language setting.....	6-22
Deleting user data	6-23
Chapter 7 Maintenance.....	7-1
Maintenance menu	7-2
Network search.....	7-3
Ping	7-5
Network connections	7-8
Chapter 8 Web settings.....	8-1
WirelessIP 5000 web settings	8-2
Overview	8-2
When setting via TELNET:.....	8-2
Access restrictions	8-2
General User Menu	8-3
Main	8-3
Phone book.....	8-4
Changing the Password.....	8-12
Chapter 9 Appendix.....	9-1
Troubleshooting.....	9-2
Text input mode.....	9-3
Number pad equivalence table	9-3
Character input method.....	9-4
Menu screens	9-6
Specifications	9-7
Glossary	9-8
INDEX.....	9-9



Chapter 1 Overview



■ Overview of this product

- This is a mobile wireless IP telephone conforming with [IEEE802.11b] standard for wireless LAN (wi-fi).
- This product supports WEP (64/128/256 bit) and WPA-PSK (TKIP) encryption formats.
- Up to 300 contacts can be registered in the phone book.
- Up to 20 calls each can be registered in the incoming and Dialed call logs.
- Calls underway can be put on hold or transferred.

This product package contains the following items. Please verify that you have all these items before using this product.
If any item in the set is missing or there is a mistake or omission in the user's manual, please contact the store of purchase.

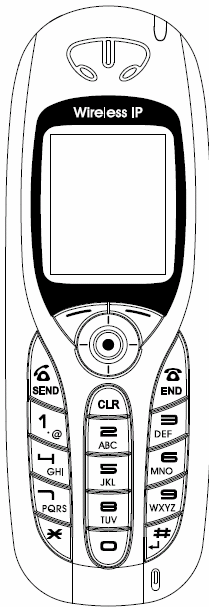

WirelessIP 5000 (1)



Charger
(1)



AC power supply
adaptor
(1)



Battery pack
(1)

Please recycle after use.

This battery pack is a recyclable lithium ion battery. Please cooperate with the promotion of recycling, for example by returning used up battery packs to the store of purchase.

Names & Functions of Device Parts

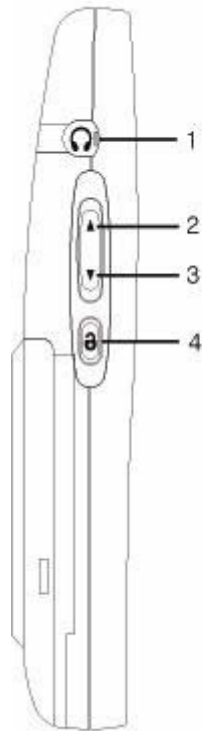



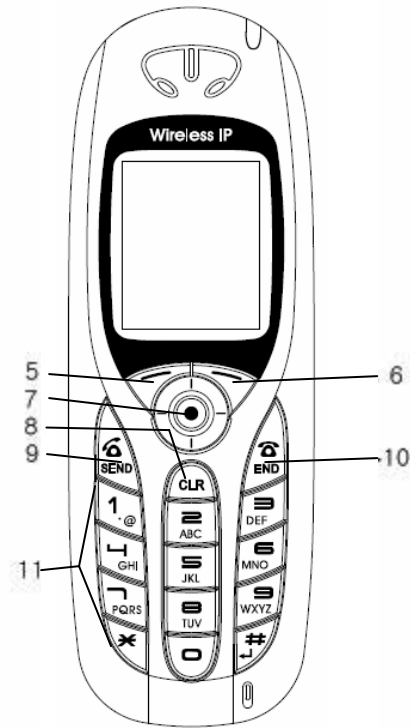

Side View







Front View

■ Explanations of the parts

No.	Name	Functions
1	Headphone jack (2.5mm 4-pole mini-jack)	Stereo mini-jack headphones can be inserted.
2	Volume Up: 	Raises the handset and ringer volumes.
3	Volume Down: 	Lowers the handset and ringer volumes.
4	Key lock 	Locks/unlocks the buttons.
5	LeftSoft key 	Used for sub-menu operation etc.
6	RightSoft key 	Used for sub-menu operation etc.

Names & Functions of Device Parts

No.	Name	Functions
7	Multi-function key 	Used for menu viewing, screen scrolling, etc. Can be pressed up and down, left and right.
8	Clear key 	Used as the "Erase" button for character input. Used as the "Return" button for menu viewing.
9	Send key 	Used for receiving and making calls.
10	End key 	Used to end a call and to switch the power ON/OFF.
11	Number pad	Inputs numbers, letters, etc. (0-9, *, #) for dialing etc. Also used for menu shortcuts.

■ Displayed icons



	Shows the reception signal strength. The more bars, the stronger the signal.
Out of service area	Shows that the location is outside the service area or is an environment where the signals do not reach.
	Shows that the ring mode is in silent mode.
	Shows that the ring mode is in vibrate mode.
	Shows that the alarm is On.
	Displayed when there is an unread message.
	Shows that the keys are locked. Key operation is disabled.
	Shows the remaining battery capacity.
	<p>Displays the current presence status. Reference: P5-11 Status</p> <ul style="list-style-type: none"> Online Picking up Briefly away from seat Away from seat Busy Lunch break Offline

These guidelines cover the accessories for this product.

Accessories

- Battery pack
- AC power supply adaptor
- Charger

Battery pack installation method

With the precaution label of the battery pack facing up, install aligning the battery pack and main unit metal terminals.

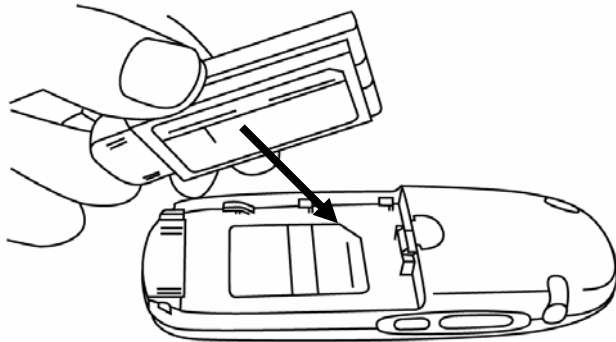

Fit the rear cover into the grooves on the main unit, then slide in direction (1) until you hear the cover click into place.

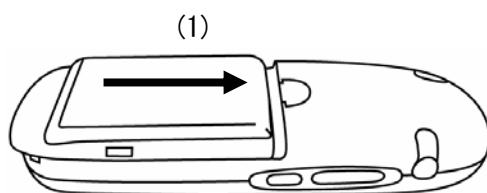

Battery pack removal

While pressing the button (1), slide the rear cover in direction (2) and remove it.

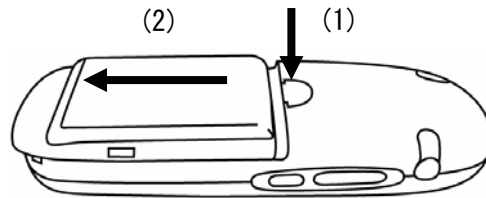

Remove the battery pack.

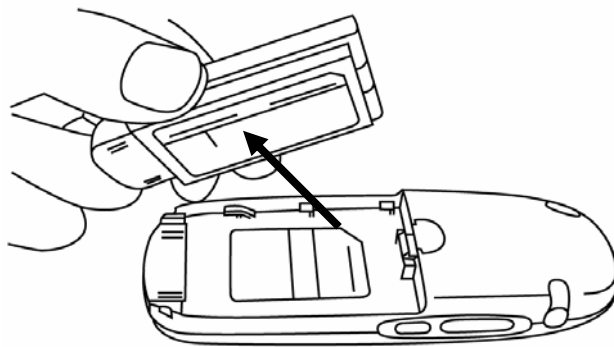

AC power supply adaptor

This product can be charged with the AC adaptor.

When using the AC power supply adaptor, plug the plug into a wall socket and connect the connector to the base of this product or to the rear of the desktop charger.

You can charge the telephone while you are using it.

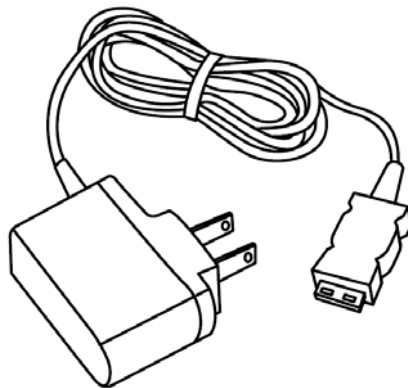

Charging method

- Plug the AC power supply adaptor into a socket and connect it to the charger.
- Insert the phone into the top of the charger until the LED lights up blue.
(The LED goes out when the charging is complete)

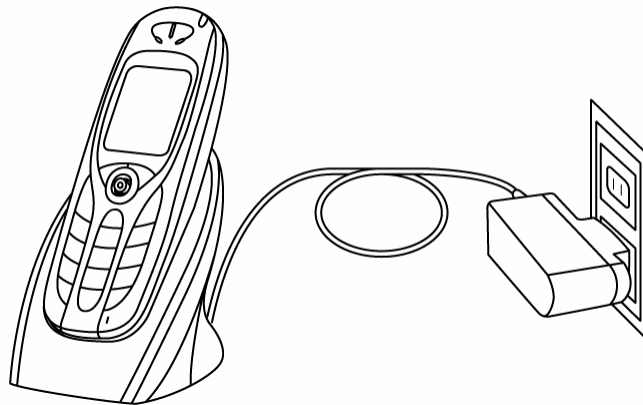

USB cable (option)

When you connect the WirelessIP5000 with a computer using the optional USB cable, you can back up the phone book and charge the phone.

When backing up the phone book to a computer, check that this product and your computer are directly connected with a USB cable.

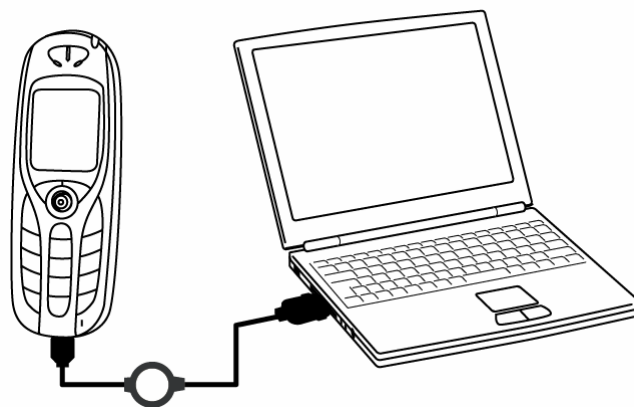



Chapter 2 Placing and Receiving Telephone Calls



Power ON

Switching on the power for this product

1

With the power Off, if you hold down the  key for at least 3 seconds, a screen like that in the figure on the right is displayed and the power comes On.



Notice

The messages "Loading...", and "Running..." are displayed in order. This processing takes a few seconds.



If the power supply does not come On charge the battery.

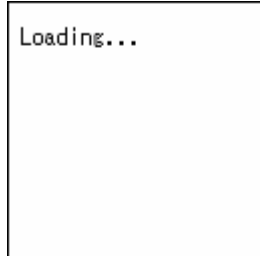

2

The standby screen is displayed.



Power OFF

Switching off the power for this product

1

With the power On, if you hold down the  key for at least 3 seconds, a screen like that in the figure on the right is displayed and the power goes Off.

















Notice











After you switch off the power, you cannot switch it back on again for 3 seconds.



Inputting the telephone number and making a call

<p>1</p>	<p>When making a call, check that the internal line number is displayed on the display</p> <p> Notice If "Not connected" or "Not registered" is displayed, this phone can not be used.</p>	
<p>2</p>	<p>Enter the telephone number, then press the  key. (When making an internal call, input the internal line number.)</p> <p>"Sending" is displayed on the display and you can hear the ringer at the other end.</p> <p> Notice If their name is registered in the contacts list, their name is displayed above the telephone number.</p>	 
<p>3</p>	<p>When the other party answers, the call time is displayed.</p> <p>You can adjust the volume with the  and  keys.</p> <p>When you press the  key, the phone goes into "mute mode" and the other party can not hear you at all.</p> <p>To end "mute mode", press the  key again.</p>	 
<p>4</p>	<p>To end the call press the  key.</p>	

Receiving an incoming call

<p>1</p>	<p>Check that the internal number is displayed on the display</p> <p> Notice If "Not connected" or "Not registered" is displayed, this phone cannot be used.</p>	
<p>2</p>	<p>When a call comes in, the other party's telephone number is displayed on the screen. If their name is registered in the contacts list, their name is displayed above the telephone number.</p> <p>You answer the incoming call by pressing the  key.</p> <p>When a call is coming in, "Incoming call" is displayed on the display.</p>	
<p>3</p>	<p>When you answer, the call time is displayed.</p> <p>When you press the  key, the phone goes into "mute mode" and the other party can not hear you at all.</p> <p>To end "mute mode", press the  key again.</p>	 
<p>4</p>	<p>To end the call press the  key.</p>	

Displays the Dialed call log and the Received call log.

1

While on standby, press the  key to select the menu.

Select "3. Call log" using the ▲▼ keys of the  key, then press the  key.



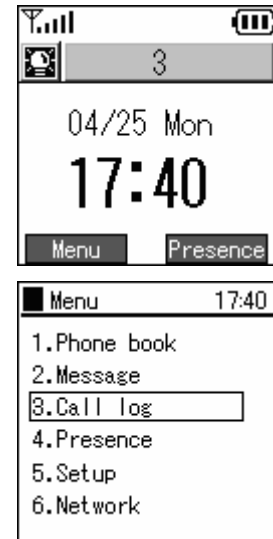

Notice

In Standby the  Key's ◀ key displays the "Received call log" and with the ▶ key you can display the "Dialed call log".





2

To display the Received call log,

Select "1. Received call" using the ▲▼ keys of the  key, then press the  key.



The incoming call list is displayed. If a name is set for a telephone number, that is displayed. If not, the telephone number is displayed.

The meanings of the icons displayed in the received call log are as follows.

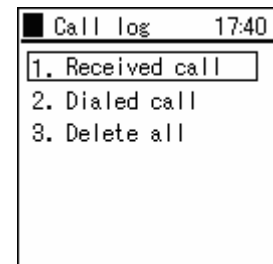
-  Received call log: Shows that a call came in and was answered.
-  Missed call log: Shows that an incoming call was not answered.



3 To display the Dialed call log,

Select "2. Dialed call log", using the ▲▼ keys of the  key, then press the  key.

The name or telephone number called is displayed in the same way as for the Received call log.

The meanings of the icons displayed in the Dialed call log are as follows.

 Dialed call log: Shows that an outgoing call was made.

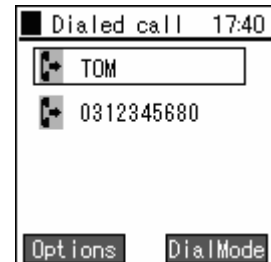
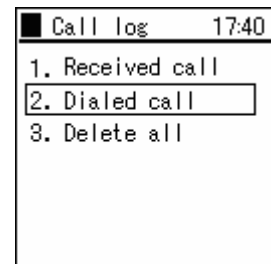

Details

Displays detailed call log information.

1 To display detailed call log information, select the Received call log or Dialed call log, then press the  key.

The following information is displayed.

- Date
- Name
- Telephone number
- Call time

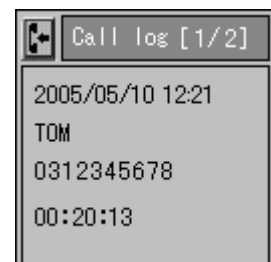

With the ◀ key of the  key you can display the previous call, and with its ▶ key you can display the next call.

2 On the detailed information screen, if you press the  key you can display the sub-menu.

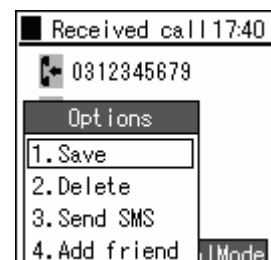



Deleting one item from the call log

Deleting one call from a call log.

1 Display a call log (Received call log or Dialed call log).

Select the call you want to delete (from the received call log or dialed call log), then press the  key to display the sub-menu.

Select "2. Delete", using the ▲▼ keys of the  key, then confirm with the  key.

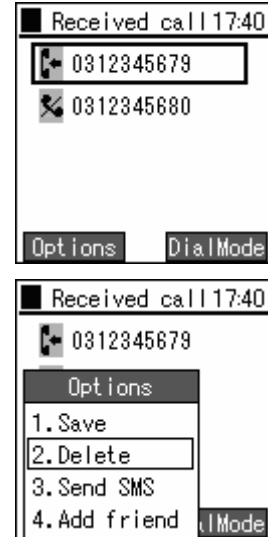

2 A confirmation message is displayed.

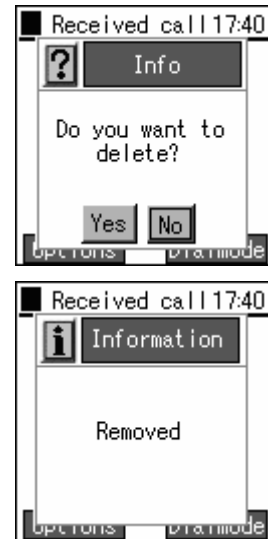

Select "Yes", using the ▲▼ keys of the  key, then confirm with the  key..

When you select "Yes", the "Removed" message is displayed.





Deleting the entire call log

Deleting entire call logs.

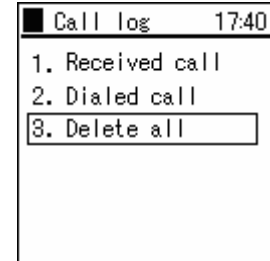
- 1 From the call log menu,
Select "3. Delete all",
using the ▲▼ keys of the  key,
then confirm with the  key.

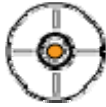

- 2 A confirmation message is displayed.
Select "Yes" using the ◀▶ keys of the  key,
then confirm with the  key.





If you select "Yes", the "Removed" message is displayed, then the display returns to the call log menu.



Redial

The last telephone number dialed is redialed.

1

In Standby, hold down the  key or the  key for at least 3 seconds.



2

The last telephone number dialed is redialed.



Notice



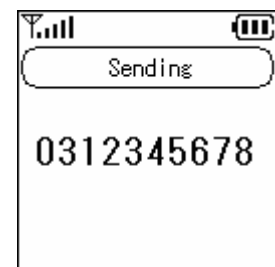

* The actual operation may vary slightly depending on the equipment connected with.



Calling from the call log

Making a call from a call log.

1

In Standby, display the Received call log using the  key of the  key. (The Dialed call log  is displayed with the  key.)

When over a name or telephone number press the  key.

A call is made to the selected telephone number.



Call from phone book

Making a call from the phone book.

1 In Standby,

the phone book search screen is displayed with the ▼ key of the  key.



2 The following five methods can be used for finding a telephone number.

- (1) By name
- (2) By Read name
- (3) By telephone number
- (4) By group
- (5) By abbreviated number

Select the search method using the ▲▼ keys of the  key, then press the  key.

Input the characters to search for on the search screen, then press the  key.

The search results are displayed as in the figure on the right.

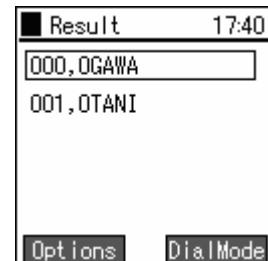
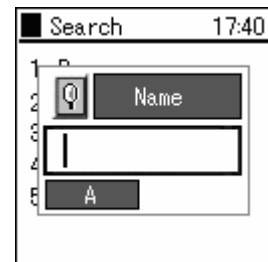
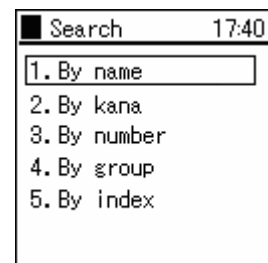

 Notice

You can search without inputting the entire search text.
Suppose that the names "Ogawa" and "Ootani" are registered as names starting with "o".

In this case, if you input "o", then press the  key, both "Ogawa" and "Ootani" are displayed.

3

Select the party to call by pressing the ▲▼ keys, then press the  key.
A call is made to the selected telephone number.



4





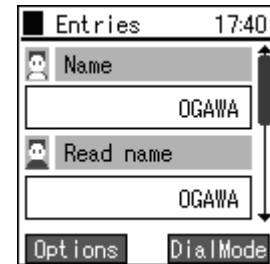







Select the name or telephone number from the search results screen, then press the  key, and detailed information is displayed.

- Name
- Read name
- Phone number
- Group
- Index



Caller ID

These commands configure settings for caller ID.

- | | | |
|----------|--|--|
| <p>1</p> | <p>In Standby, Press the  key to select the menu.</p> <p>Select "5. Setup" using the ▲▼ keys of the  key, then confirm with the  key.</p> |  <p>04/25 Mon
17:40
Menu Presence</p> <p>Menu 17:40</p> <ul style="list-style-type: none"> 1. Phone book 2. Message 3. Call log 4. Presence 5. Setup 6. Network |
| <p>2</p> | <p>From the settings menu,</p> <p>Select "7. Advanced", using the ▲▼ keys of the  key, then confirm with the  key.</p> |  <p>Setup 17:40</p> <ul style="list-style-type: none"> 2. Phone lock 3. Alarm 4. Volume 5. Error notify 6. Information 7. Advanced |
| <p>3</p> | <p>From the equipment settings menu,</p> <p>Select "5. Caller ID", using the ▲▼ keys of the  key, then confirm with the  key.</p> |  <p>Advanced 17:40</p> <ul style="list-style-type: none"> 1. Time 2. Contrast 3. Font size 4. Language 5. Caller ID 6. User data reset |
| <p>4</p> | <p>Select "On" or "Off" using the ◀▶ keys of the  key, then confirm with the  key.</p> |  <p>Advanced 17:40</p> <p>1. Time</p> <p>Caller ID</p> <p>On</p> <p>5. Caller ID</p> <p>6. User data reset</p> |

Speed Dialing

Making a call with a speed dialing number.

1 Input a speed dialing number registered in the phone book.

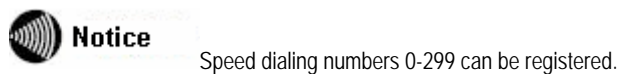

2 Press the last digit in the speed dialing number and hold it down for at least 1 second.
For example, for a speed dialing number of 100, hold down the "0" for at least one second.

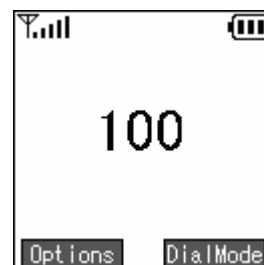

3 A call is made to the registered speed dial number.



Hold function

This is used to put a call on hold. The hold tones are played for the other party who is on hold.

■ Hold

Pressing the  key during a call puts the call on hold.

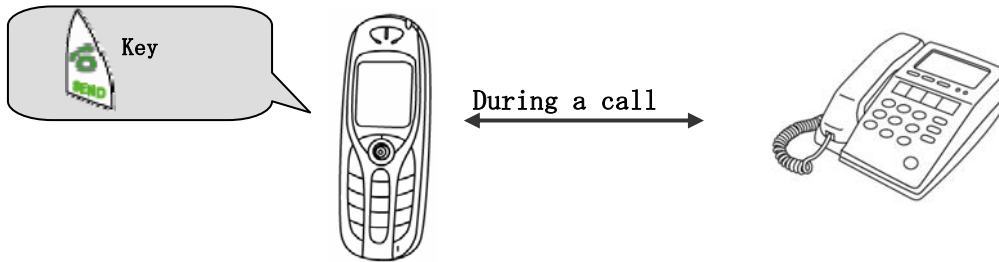

The hold tone is played for the other party on hold.

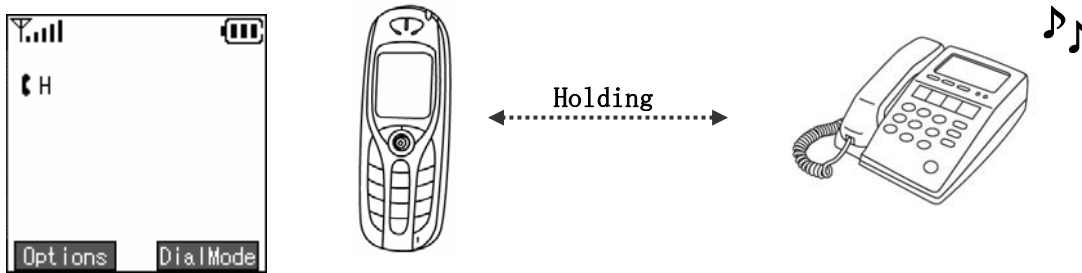

■ Ending a hold

The hold on the call is ended if you press the  key during a hold,.

Call waiting

If you are on one call and another call comes in, you can put the first call on hold and answer the new incoming call.
If you are on one call and another call comes in, the incoming terminal plays the incoming call tone (beeping) and displays "Standby" on the display.



Notice

With some connection equipment, this is not possible.

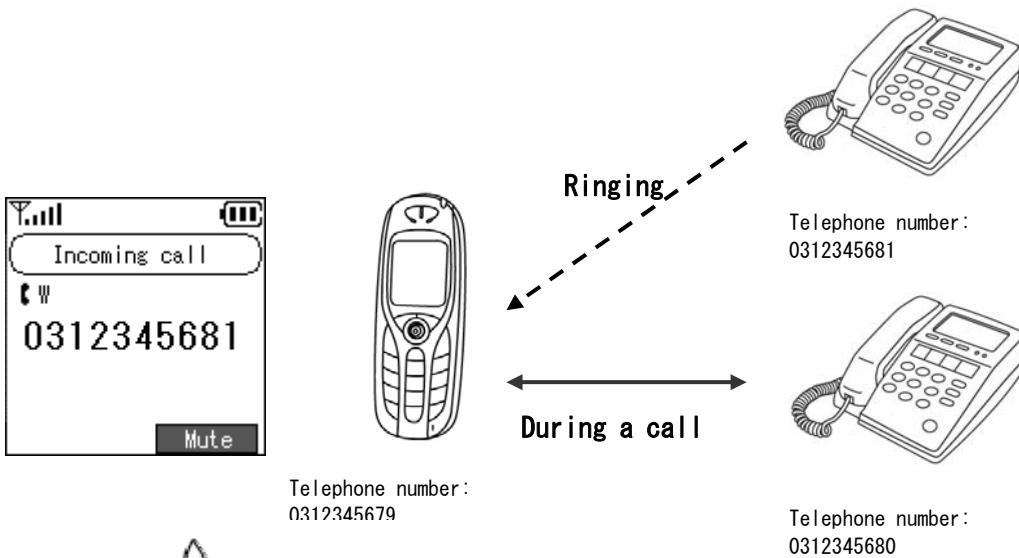

If you press the  key, the call is placed on hold and you can receive the new call.

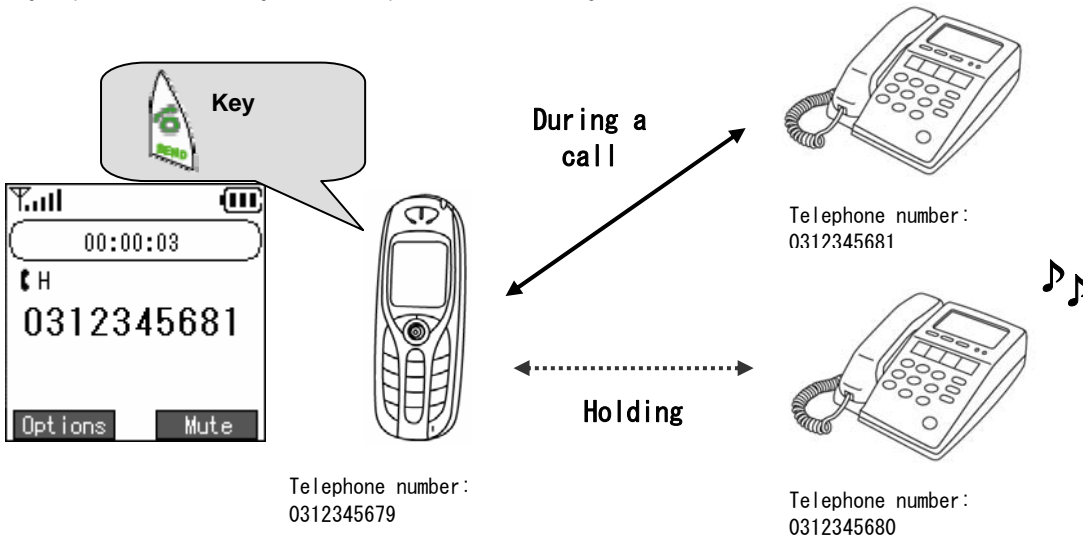

● Switching operation

Pressing the  key again toggles between the two calls.

Hold transfer

You can transfer a call to another internal line.



Notice

Calls can only be transferred external line -> internal or internal -> internal.

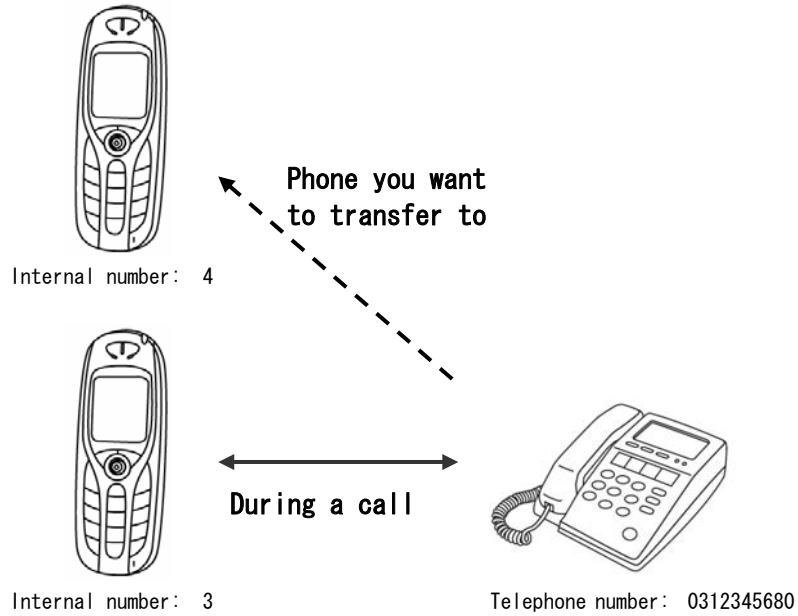

Press the  key to put your current call on hold.

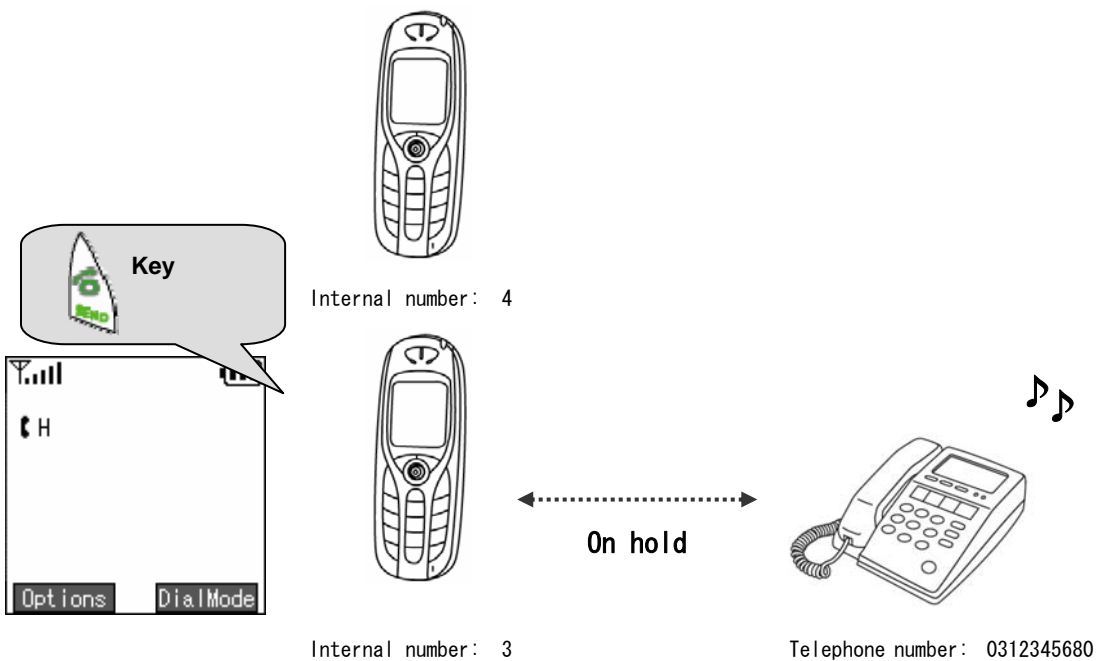

Input the internal number to transfer to then press the  key.

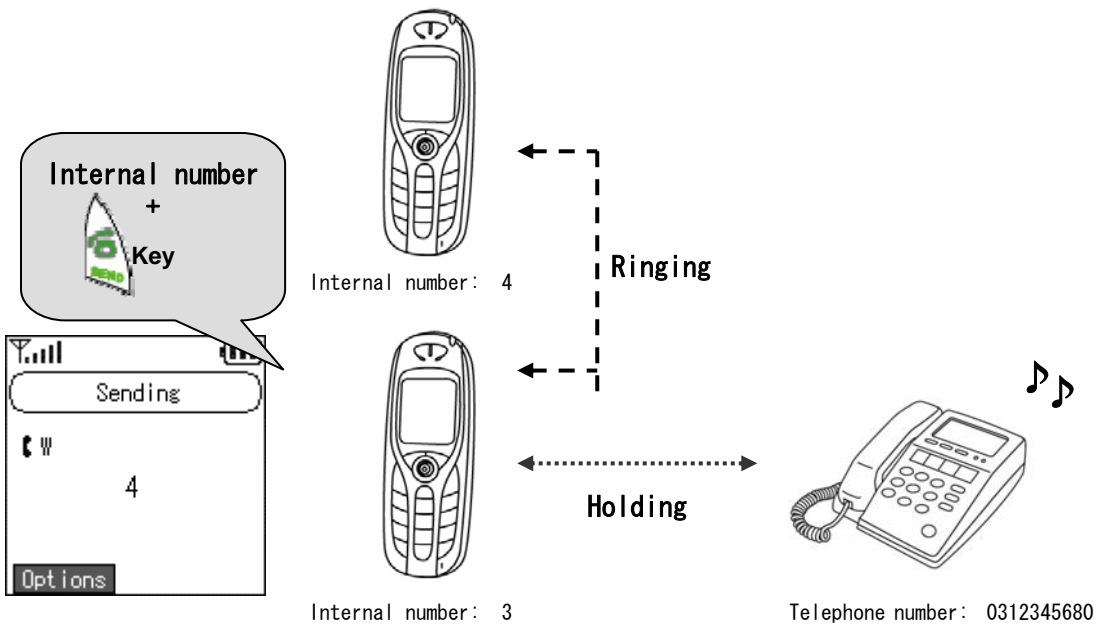



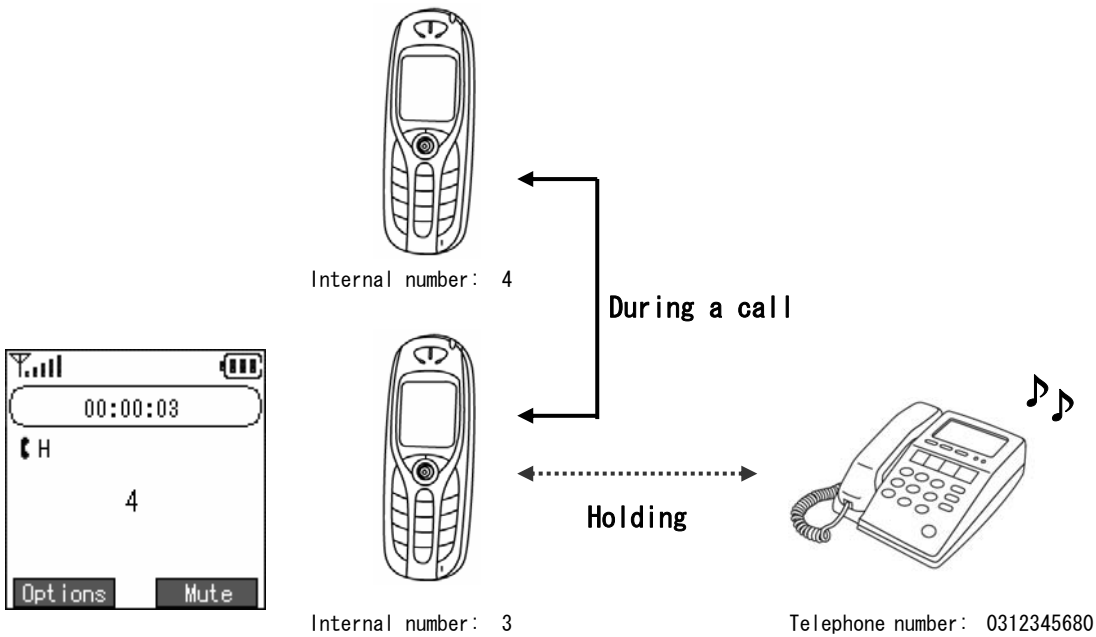

The call is connected to the internal line.



 **Notice**

If you are cut off from the first caller while you are trying to call the party to transfer to, or while you are talking with the party to transfer to, "Cutoff" is displayed and after about 10 seconds the call is automatically switched back to the external line.

Also, during display, if you press the  key or  key you are immediately switched back to the external line call.
 * The actual operation may vary slightly depending on the server used.

Press the  key to select "1. Transfer" on the sub-menu, then press the  key.

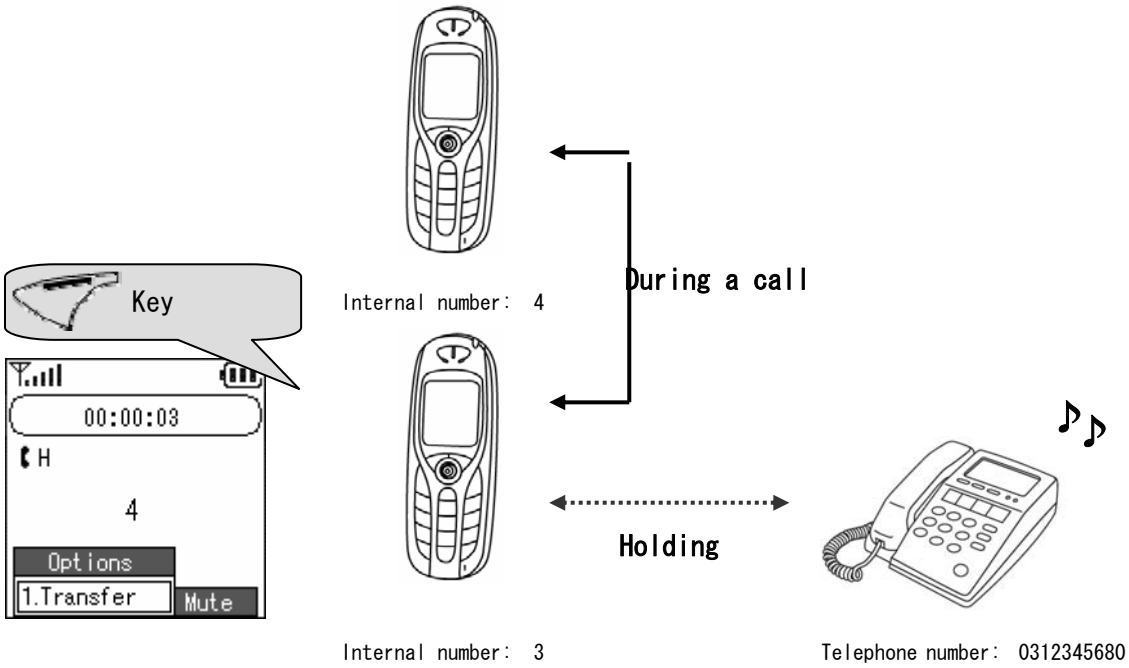

The call is transferred.

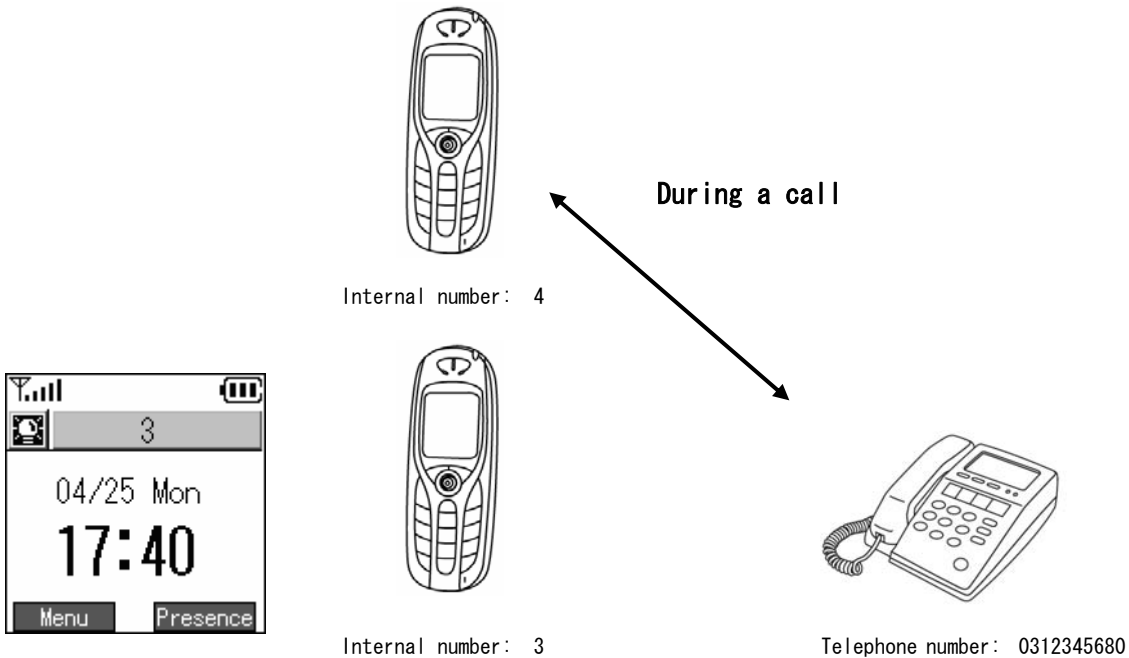





Chapter 3 Phone book



Registering, editing, and deleting contacts in the phone book

1

In Standby, press the  key to select the menu.

Select "1. Phone book". using the ▲▼ keys of the  key, then press the  key.

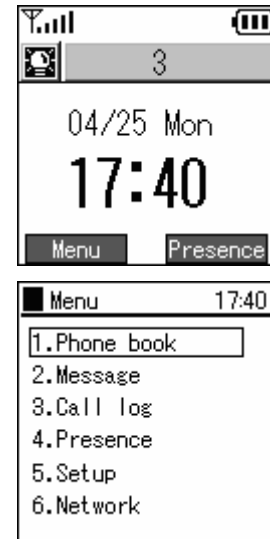

Registration from phone book menu

Registering information into the phone book from the new registration menu

1

From the phone book menu, select "2. New number" using the ▲▼ keys of the



key,
then press the  key.

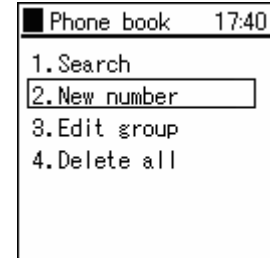

2

Please enter your information.

Name: Please enter the name.

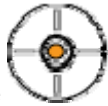

After inputting this, press the ▼ key of the  key.

Read name: Please enter the Read name for the name.

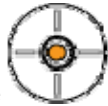

After inputting this, press the ▼ key of the  key.

Telephone number: Please enter the telephone number.

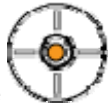

After inputting this, press the ▼ key of the  key.

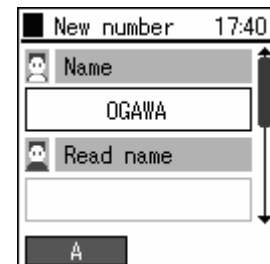

Notice

If nothing is input in the read name column during phone book registration "No name" is displayed.

Phone book registration

3

Group: Press the  key to select a group.



Notice

At first, it is set to "Undefined".

Select the group using the ▲▼ keys of the  key, then press the  key.

After inputting this, press the ▼ key of the  key.

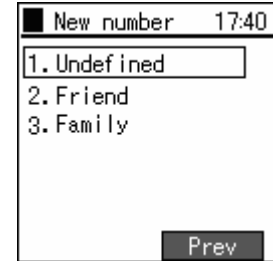
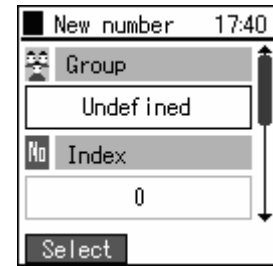

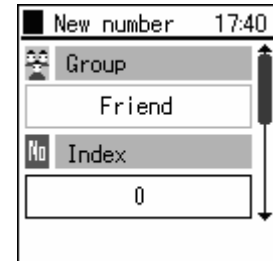

4

Speed dialing number: Please enter the speed dialing number.



5

After inputting the necessary information, press the  key to store the information.

To revise a value, move to the item to be revised with the ▲▼ keys of the  key, revise its value, and press the  key to save the information.



Notice

If you press the  key without entering the telephone number, a warning message like that on the right is displayed.

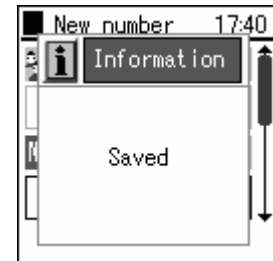

Registration from a telephone number

Inputting a telephone number to register it into the phone book

1

During standby, enter the telephone number, and press the



key to display

Select "2. Save".

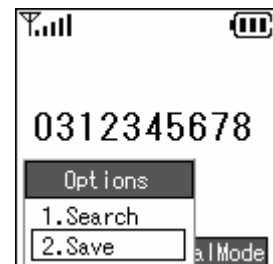

2

Please enter your information.
Name: Please enter the name.

After inputting this, press the ▼ key of the



key.

Read name: Please enter the Read name for the name.

After inputting this, press the ▼ key of the

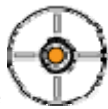

key.

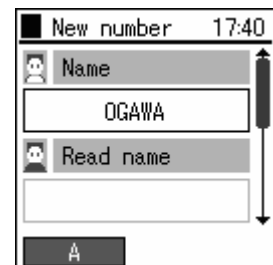

Notice

If nothing is input in the read name column during phone book registration "No name" is displayed.

Phone book registration

3

Group: Press the  key and select a group.

Select the group using the ▲▼ keys of the  key, then press the  key.

After inputting this, press the ▼ key of the  key.

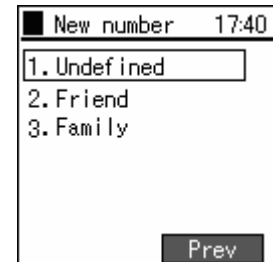
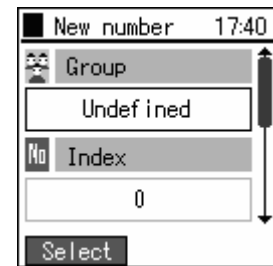

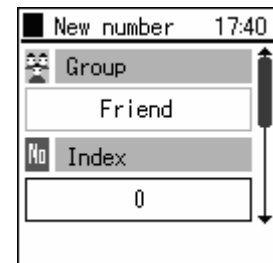

4

Speed dialing number: Please enter the speed dialing number.



5

After inputting the necessary information, press the  key to save the information.

To revise a value, move to the item to be revised with the ▲▼ keys of the  key, and revise its value.
Press the  key to save the information.

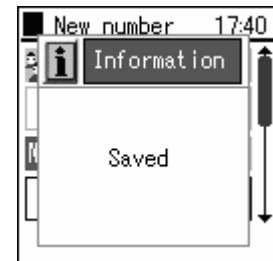

Registration from a call log

Registering details into the phone book from the call log.

1 Display the call log.

Select the number to register, press the  key to display the sub-menu.

Select "1. Save".

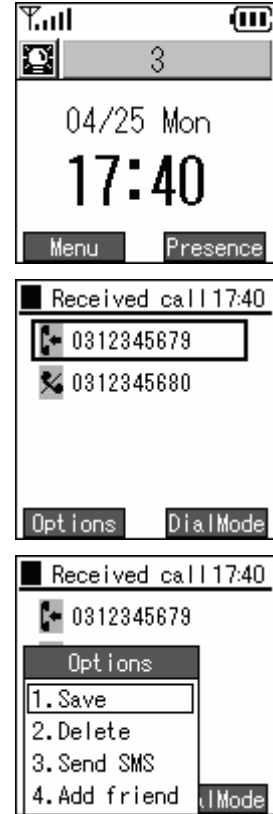

2 Input the information.

Name: Please enter the name.

After inputting this, press the  key of the  key.

Read name: Please enter the Read name for the name.

After inputting this, press the  key of the  key.

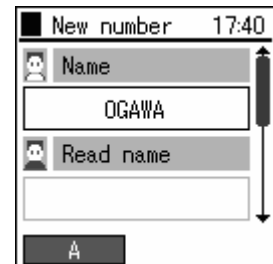

Notice

If nothing is input in the Read name column during phone book registration "No name" is displayed.

3

Group: Press the  key and select a group.

Select the group using the ▲▼ keys of the  key, then press the  key.

After inputting this, press the ▼ key of the  key.

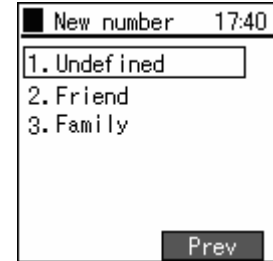
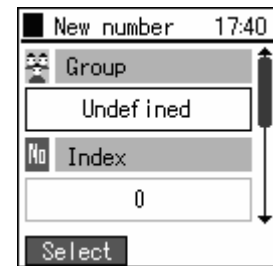

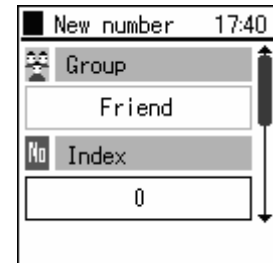

4

Speed dialing number: Please enter the speed dialing number.



5

After inputting the necessary information, press the  key to save the information.

To revise a value, move to the item to be revised with the ▲▼ keys of the  key, revise its value, and press the  key to store the information.

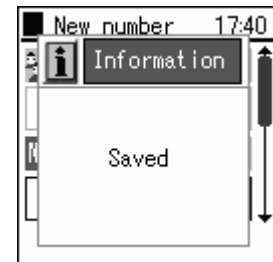

Editing the phone book from search results

1 Search for the registration information you want to edit.

Select the number you want to edit, press the  key to display the sub-menu.
Select "2. Edit".

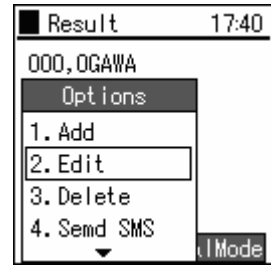
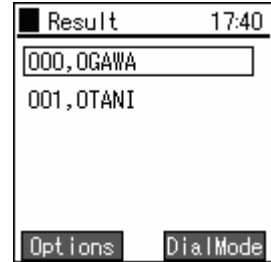
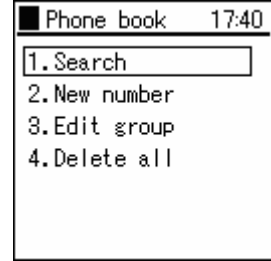

2 Input the information.

Name: Please enter the name.

After inputting this, press the ▼ key of the  key.

Read name: Please enter the Read name for the name.

After inputting this, press the ▼ key of the  key.

Telephone number: Please enter the telephone number.

After inputting this, press the ▼ key of the  key.



Notice

If nothing is input in the read name column during phone book registration "No name" is displayed.

3 Group:  Please press the  key and select a group.

Select the group using the ▲▼ keys of the  key, then press the  key.

After inputting this, press the ▼ key of the  key.

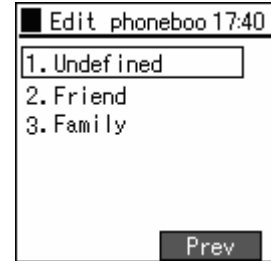
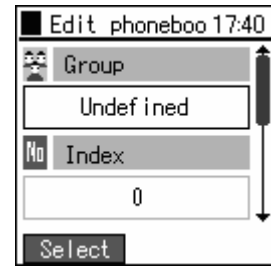

4 Speed dialing number: Please enter the speed dialing number.



5 After inputting the necessary information, press the  key to save the information.







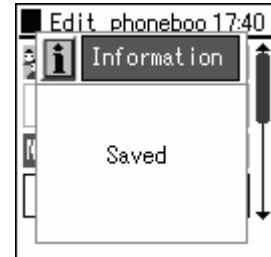





To revise a value, move to the item to be revised with the ▲▼ keys of the  key, revise its value,

and press the  key to store the information.

 **Notice** If you press the  key, a warning message is displayed.



Editing a phone book group name.

<p>1</p>	<p>Select "3. Edit group" using the ▲▼ keys of the  key, then press the  key.</p>	 <p>Phone book 17:40 1. Search 2. New number 3. Edit group 4. Delete all</p>
<p>2</p>	<p>To add a group, press the  key to display the sub-menu. Select "1. Add".</p>	 <p>Edit group 17:40 1. Undefined Options 1. Add 2. Edit 3. Delete</p>
<p>3</p>	<p>Input the group name, and save with the  key.</p>	 <p>Edit group 17:40 1. Undefined Add Friend A Options</p>
<p>4</p>	<p>To edit a group, select the name of the group to edit using the ▲▼ keys of the  key, press the  key to display the sub-menu. Select "2. Edit".</p> <p> Notice "1. Undefined" can not be edited.</p>	 <p>Edit group 17:40 1. Undefined 2. Friend Options 1. Add 2. Edit 3. Delete</p>
<p>5</p>	<p>When the group name editing is complete, save with the  key.</p>	 <p>Edit group 17:40 1. Undefined 2. Edit group Friend A Options</p>

6 To delete a group, select the name of the group to delete using the ▲▼ keys of the



key,



press the key to display the sub-menu.

then select "3. Delete".



Notice

"1. Undefined" can not be deleted.

7 A confirmation message is displayed.

Select "Yes" using the ◀▶ keys of the

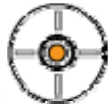

key,

then confirm with the  key.

If you select "Yes", the "Removed" message is displayed, then the display returns to the phone book menu.

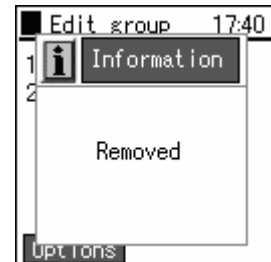



Notice

The telephone numbers registered in the deleted group are moved to "1. Undefined".

Deleting one item from phone book

Deleting one data item from the phone book.

1

Select "1. Search" using the ▲▼ keys of the  key, then press the  key.

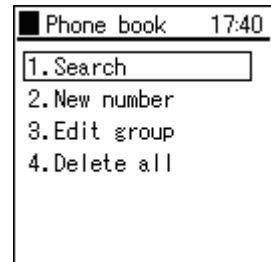

2

Search for the telephone number you want to delete.

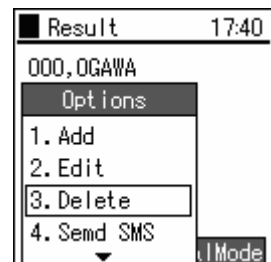
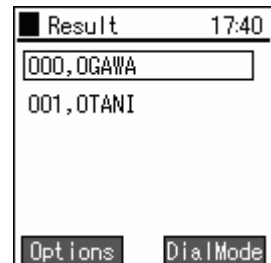
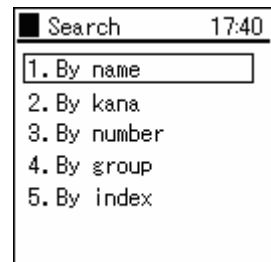
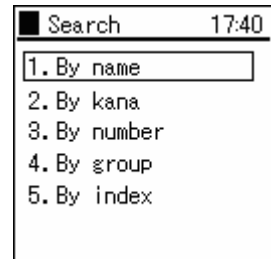

After selecting the telephone number you want to delete,  press the key to display the sub-menu.

Then select "3. Delete".



Deleting one item from phone book

3 A confirmation message is displayed.

Select "Yes" using the ◀▶ keys of the  key,
then confirm with the  key.

If you select "Yes", the "Removed" message is displayed, then the display returns to the search menu.

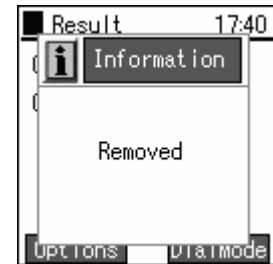

Deleting entire phone book

Deleting all the data in the phone book.

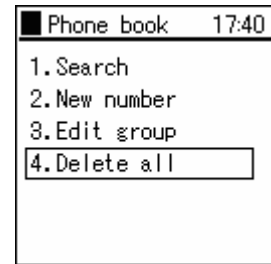

1

Select "4. Delete all" using the ▲▼ keys of the  key, then press the  key.

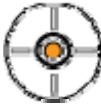

2

A confirmation message is displayed.

Select "Yes" using the ◀▶ keys of the  key, then confirm with the  key.

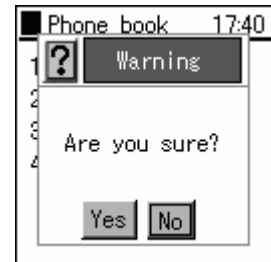

3

If you select "Yes", the process for deleting the entire phone book is executed.

The "Removed" message is displayed, then the display returns to the phone book menu.

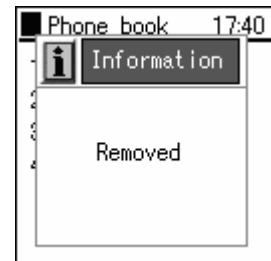
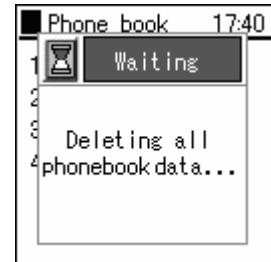



Chapter 4 Messaging



Displaying the Message menu

1

In Standby, press the  key to select the menu.

Select "2. Message" using the ▲▼ keys of the  key, then press the  key.



Notice

With some connection equipment, this is not possible.



Displays, edits, and deletes received messages.

1 The message icon is displayed on the standby screen when there is an unread message.

To display the message,
from the IM menu,

Select "1. Recv. box" using the ▲▼ keys of the  key,
then press the  key..

If there is an unread message, a screen is displayed showing the number of unread messages.



2 A list of the messages is displayed.

Select a message using the ▲▼ keys of the  key.
The selected message is automatically scrolled horizontally to display the entire message. You can also use the ◀▶ keys to check a message manually.



3 When you select a message and press the  key, a confirmation screen like that in the figure on the right is displayed

The following information is displayed.

- Date
- Telephone number
- Message contents



4 To reply to a received message, select the message to reply to from the Inbox list screen,

Then press the  key to select the sub-menu and select "1. Reply".

Input the message with the number pad.

Finally, confirm with the  key.

Next, input the telephone number to send to.
As many as ten recipient destinations can be specified.

By pressing the  key, a confirmation screen like that in the figure on the right is displayed.

Select "Yes" using the  keys of the  key,

then confirm with the  key.

The message is sent.

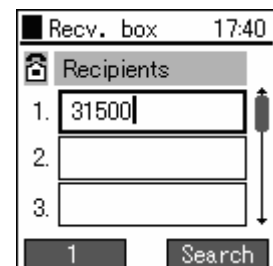
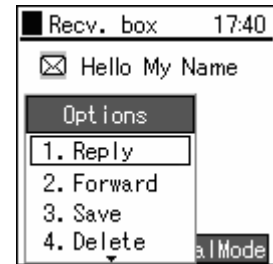
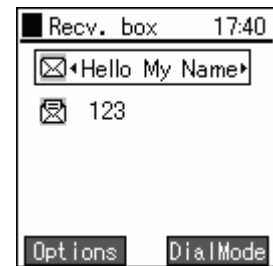

5 To forward a received message, select the message to forward from the Recv. box list screen,

Then press the  key to select the sub-menu and select "2. Forward".

Input the message with the number pad.

Finally, confirm with the  key.

Input the telephone number to send to.
As many as ten recipient destinations can be specified.

By pressing the  key, a confirmation screen like that in the figure on the right is displayed.

Select "Yes" using the   keys of the  key,

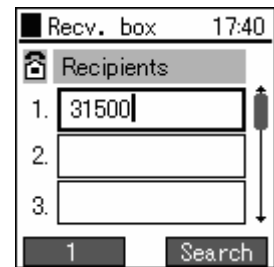
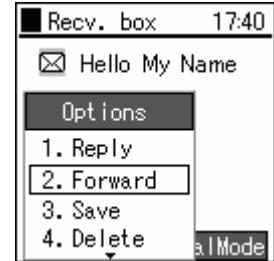

then confirm with the  key.

The message is sent.



- 6 To delete a message, select the message to delete from the Recv. box list, then press the  key to select the sub-menu and select "4. Delete".



The screen in the figure on the right (3rd screen down) is displayed.

Select "Yes" using the ◀▶ keys of the  key, then confirm with the  key. The message is deleted.





- 7 To delete all the messages in the Inbox, from the Recv. box list screen press the  key to select the sub-menu and select "5. Delete all".

A confirmation screen like that in the figure on the right is displayed.

Select "Yes" using the ◀▶ keys of the  key, then confirm with the  key. All the messages in the Recv. box are deleted.





Writing and sending a new message.

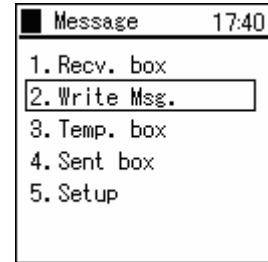

- 1 from the Message menu,
Select "2. Write Msg.", using the ▲▼ keys of the  key, then press the  key.

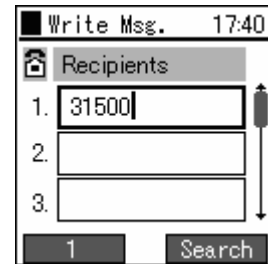

- 2 Input the message with the number pad.
Finally, confirm with the  key.
Input the telephone number to send to.
As many as ten destinations can be specified.

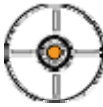

- 3 By pressing the  key, a confirmation screen like that in the figure on the right is displayed.

Select "Yes" using the ◀▶ keys of the  key, then confirm with the  key.

The message is sent.

The processing during sending is displayed as in the figure on the right.

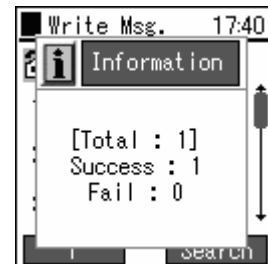

The send results screen is displayed immediately.



An unsent message is stored temporarily.

1

If you are not sending the message right away, then press the  key when creating the message to save it for later use.



Select "Yes" using the ◀▶ keys of the  key, then press the  key.

The message is stored as a draft.

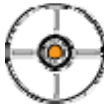

2

To edit, send, or check a message stored as a draft, from the message menu,

Select "3. Temp. box" using the ▲▼ keys of the  key, then press the  key.

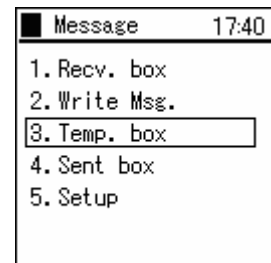

3

A list of messages stored as drafts is displayed.

Use the ▲▼ keys of the  to select a message.

The selected message is automatically scrolled horizontally to display the entire message. You can also use the ◀▶ keys to check a message manually.



4

If the  key is pressed for a message selected from the list, a confirmation screen like that in the figure on the right is displayed

- Date
- Telephone number
- Message contents

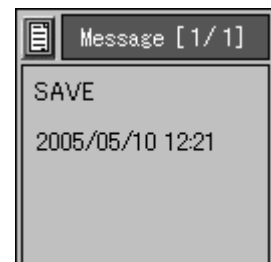

5

To edit a "draft" message, select that message, press the  key to select the sub-menu, then select "1. Edit".

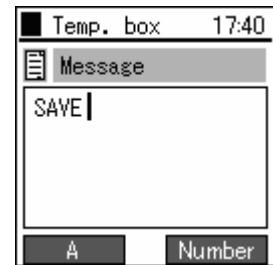
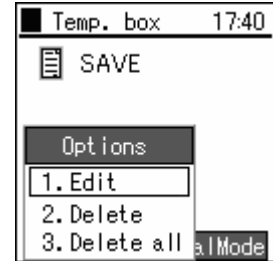
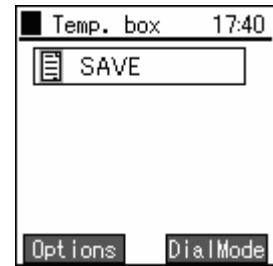

The screen becomes as in the figure on the right, so with the  keys of the



key move to the input column you want to edit and edit it.

The edited message can be sent with the same procedure as for sending a newly created message.

6

To delete a "draft", press the  key to select the sub-menu, then select "2. Delete".

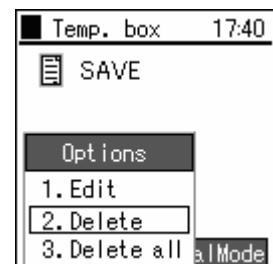
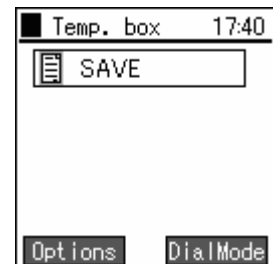

A confirmation screen like that in the figure on the right is displayed.

Select "Yes" using the  keys of the  key,

then confirm with the  key.

The message is deleted.

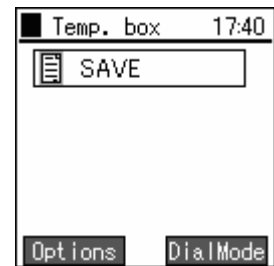

7

To delete all the "draft" messages, from the Temp. box screen, press the  key to select the sub-menu, then select "3. Delete All".

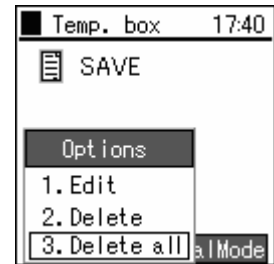

A confirmation screen like that in the figure on the right is displayed.





Select "Yes" using the ◀▶ keys of the  key, then confirm with the  key. All the draft messages are deleted.

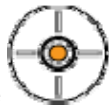

Displaying, editing, deleting, and re-sending of sent messages

1 from the Message menu,

Select "4. Sent box" using the ▲▼ keys of the  key, then press the  key



2 A list of the messages sent in the past is displayed.

Use the ▲▼ keys of the  key to select a message.

The selected message is automatically scrolled horizontally to display the entire message. You can also use the ◀▶ keys to check a message manually.



3 When you select a message and press the  key, a screen like that in the figure on the right is displayed.

The following information is displayed.

- Date
- Telephone number
- Message contents



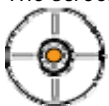

4 To edit a sent message, after selecting the message you wish to edit from the Sent box list screen, press the  key and select "1. Edit" from the submenu.

The screen becomes as in the figure on the right, so with the ▲▼ keys of the  key, move to the input column you want to edit and edit it.



Finally, confirm with the  key.

The edited message can be sent with the same procedure as for sending a newly created message.



- 5 To delete a sent message, after selecting the message you wish to delete from the Sent box list screen, press the  key and select "2. Delete" from the submenu.

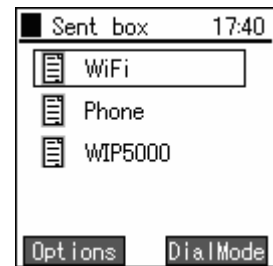

A confirmation screen like that in the figure on the right is displayed.

Select "Yes" using the ◀▶ keys of the  key, then confirm with the  key. The message is deleted.



- 6 To delete all the messages in the Sent box, from the Sent box list screen press the  key to select the sub-menu, then select "3. Delete All".

A confirmation screen like that in the figure on the right is displayed.

Select "Yes" using the ◀▶ keys of the  key, then confirm with the  key. All the messages in the Sent box are deleted.



Configure the ring tone and mode when a message arrives.

1

from the Message menu,

Select "5. Setup", using the ▲▼ keys of the  key, then press the  key.

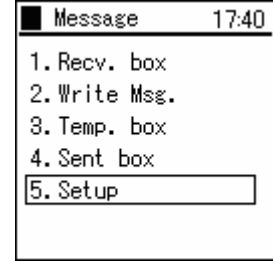

2

Displays configuration information.

Using the  key, select "Edit."

There are 16 ring types. (Bell 1~Bell 16)

There are four modes.

	Ring	Vibration	Ring+Vib	LED
Ringer	Yes	×	Yes	×
Vibrator	×	Yes	Yes	×

Finally, save with the  key.

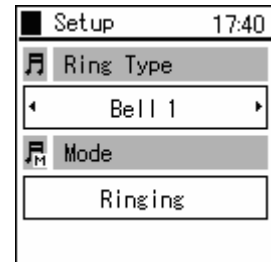



Chapter 5 Presence

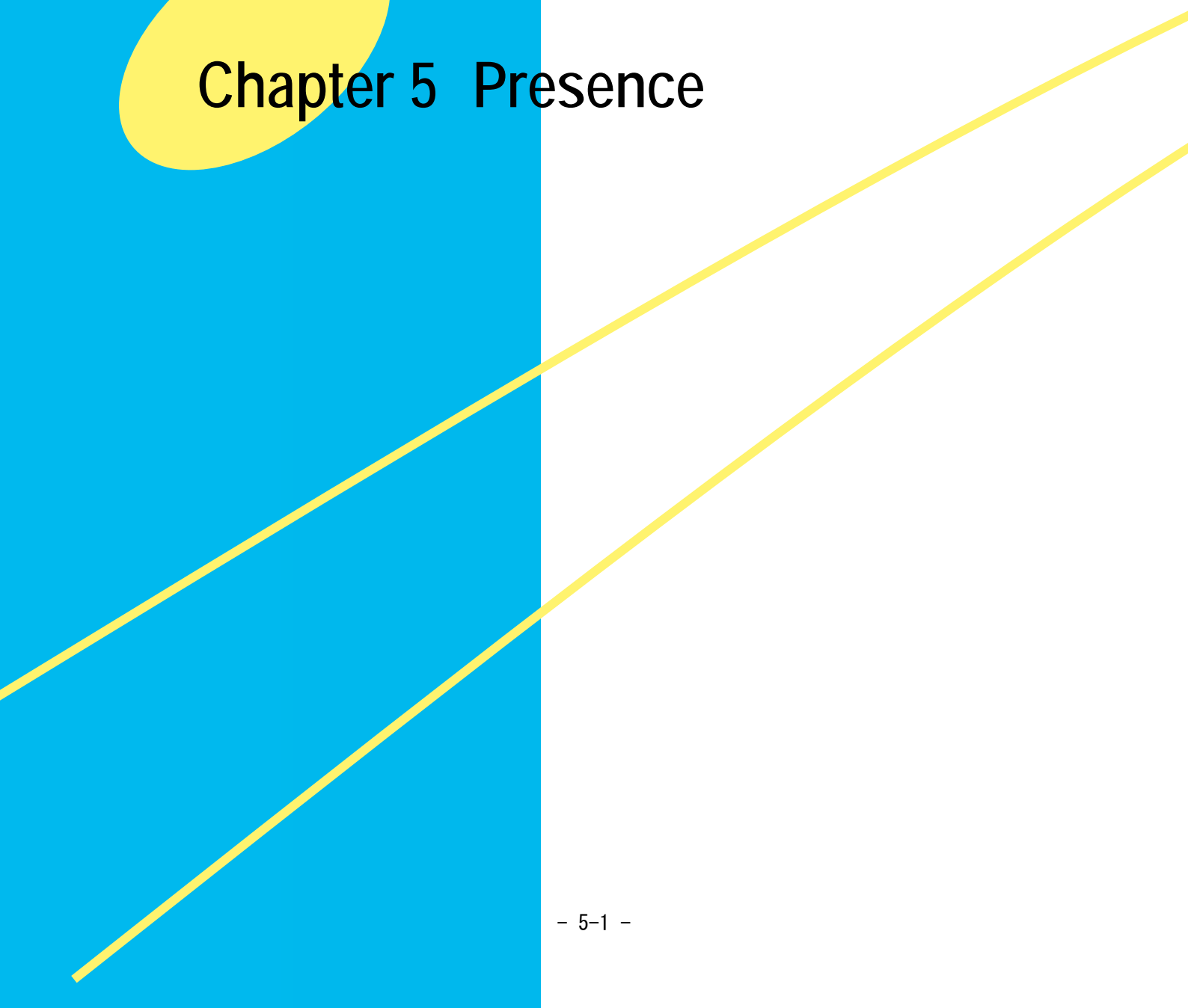

Displays the presence menu.

1

In Standby, press the  key to select the menu.

Select "4. Presence" using the ▲▼ keys of the  key, then press the  key.



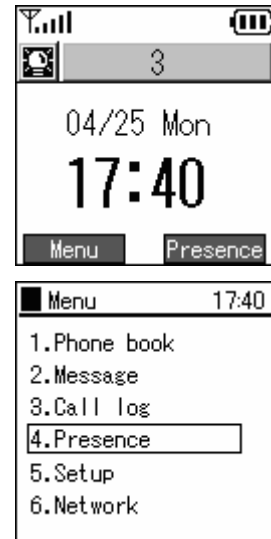

With some connection equipment, this is not possible.



Displaying a list of registered users

1 From the presence menu,

Select "1. User list" using the ▲▼ keys of the  key, then press the  key.



2 A list of registered users is displayed.



3 To register a user, on the user list screen, press the  key to select the sub-menu and select "1. Add".

Use the number pad to enter the user's telephone number.

If you try to input a user who is already registered, the "Already Registered" message is displayed and the display returns to the input field.

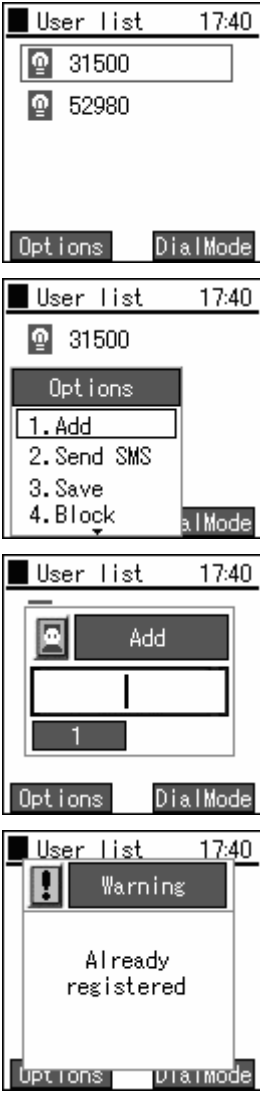

- 4 To send a message to a registered user, select that user from the user list screen, then press the  key to select the sub-menu and select "2. Send SMS".

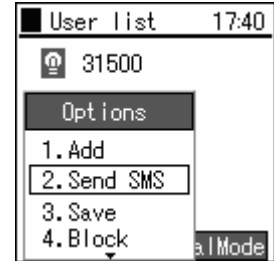
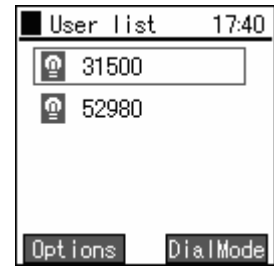

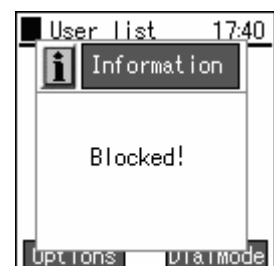
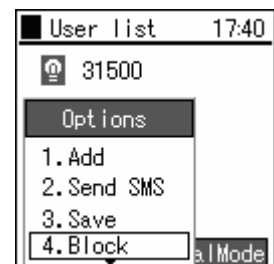
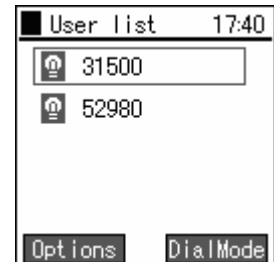

- 5 To register a registered user in the blocked list, select that user from the user list screen, press the  key to display the sub-menu, then select "4. Block".



- 6 To delete a registered user, select that user from the user list screen, then press the  key to select the sub-menu, then select "5. Delete".

A confirmation screen like that in the figure on the right is displayed.

Select "Yes" using the ◀▶ keys of the  key, then confirm with the  key. The user is deleted.

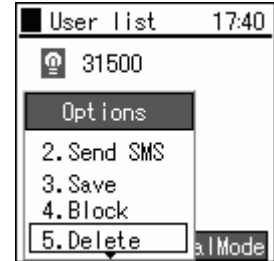
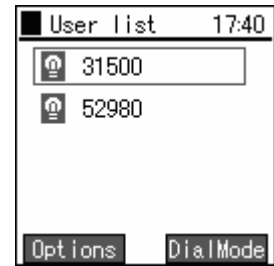

7

To delete all the registered users, from the user list screen, press the



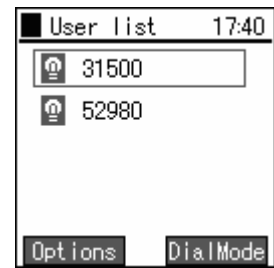

key to

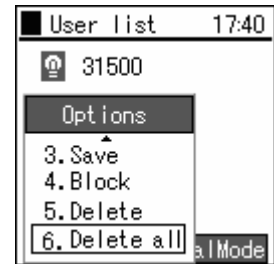

A confirmation screen like that in the figure on the right is displayed.



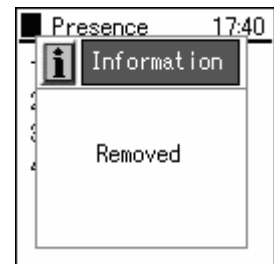

Select "Yes" using the ◀▶ keys of the  key, then confirm with the  key. The registered users are all deleted.



Displaying a list of users registered in the block list. Your status is not disclosed to users registered in the block list.

1 From the presence menu,

Select "2. Block list" using the ▲▼ keys of the  key, then press the  key.

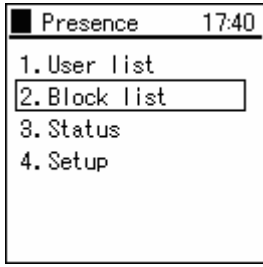

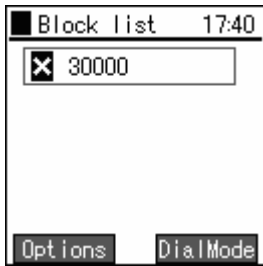

2 Displaying a list of users registered in the block list.



3 To add a user to the block list, from the user list screen, press the  key to select the sub-menu and select "1. Add".

Use the number pad to enter the user's telephone number.

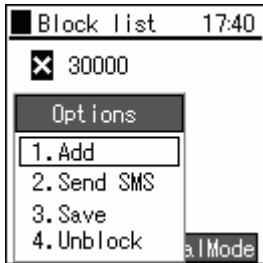
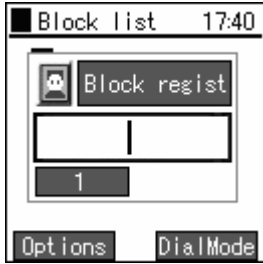
If you try to input a user who is already registered, the "Already registered" message is displayed and the display returns to the input field.



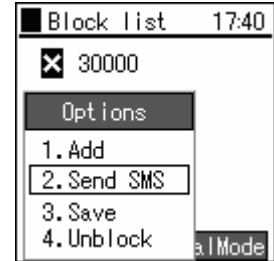
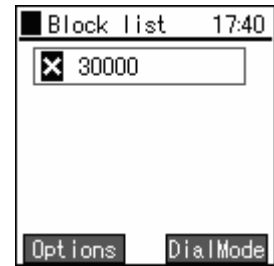

Block list

- 4 To send a message to a registered user, select that user from the block list screen, then press the  key to select the sub-menu and select "2. Send SMS".

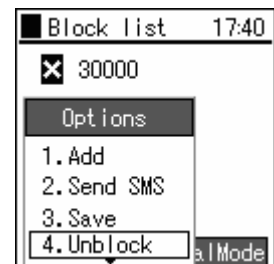
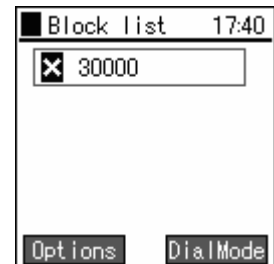

- 5 To unblock a user, select that user from the block list screen, then press the  key to display the sub-menu, then select "4. Unblock".





The selected user is moved from the blocked list to the user list.



- 6 To delete a registered user, select that user from the block list screen, then press the  key to select the sub-menu, then select "5. Delete".

A confirmation screen like that in the figure on the right is displayed.

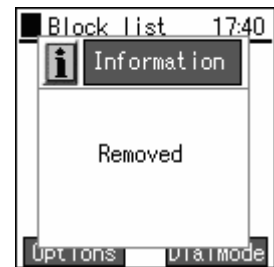
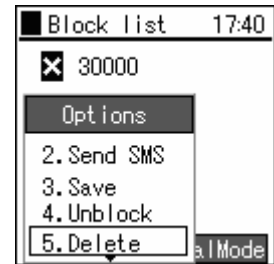
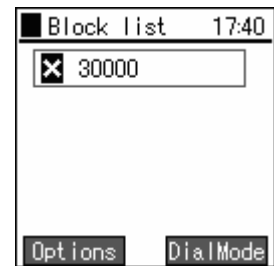

Select "Yes" using the ◀▶ keys of the  key, then confirm with the  key. The user is deleted.

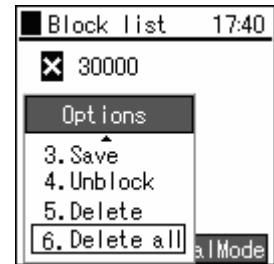
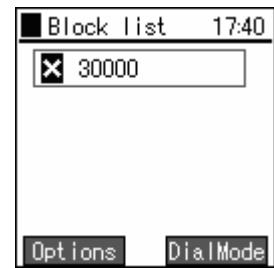

7 If you want to delete all the registered users, from the block list screen press the  key to select the sub-menu, then select "6. Delete All".



A confirmation screen like that in the figure on the right is displayed.

Select "Yes" using the ◀▶ keys of the  key, then confirm with the  key.

All the users on the block list are deleted.

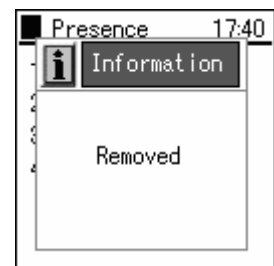
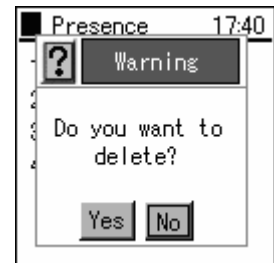

Changing your own status.

1

From the presence menu,

Select "3. Status", using the ▲▼ keys of the  key, then press the  key.

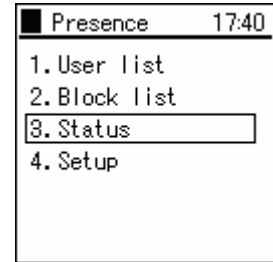

2

You can set the status by using the ◀▶ keys of the  key, then pressing the  key.

There are seven statuses.

: OnLine

: Busy

: BeRightBack

: Away

: OnThePhone



: OnToLunch

: OffLine

Finally, save with the  key.



Displays the setting menu.

1 From the presence menu,
Select "4. Setup" using the ▲▼ keys of the  key, then press the  key.

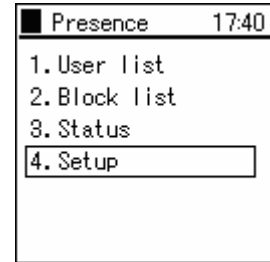

2 Displays configuration information.

- Online bell
- Ring Type
- Mode

To change a setting,  press the key, select "Edit", then select the new value.

For the online level, select "Enabled" or "Disabled".

There are five ring types (Ring 1 ~ Ring 5)

There are four modes.

	Ringing	Vibration	Ring+Vib	LED
Ringer	Yes	×	Yes	×
Vibrator	×	Yes	Yes	×

Finally, save with the  key.

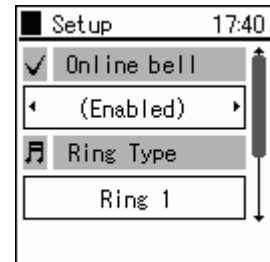
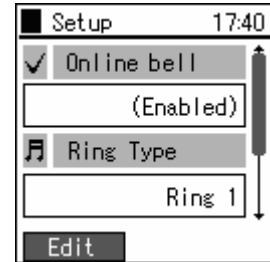



Chapter 6 Other settings



Manner mode On/Off

When Manner mode is set, the ringer does not ring and all ringers go into vibration mode.

- 1 With the phone on standby, hold down the "*" key on the number pad for at least 1 second.

The phone goes into Manner mode.



- 2 When the phone goes into Manner mode, the Manner mode icon is displayed on the screen.



- 3 To end Manner mode, press and hold down the "*" key on the number pad again.

Manner mode ends.



Setting/Ending keylock

When the keylock is set, button operations are disabled.



Notice

You can lock the keys to prevent accidental operation of keys, for example when you walk around with the phone's power On.

1

In Standby, hold down the  key for at least one second.

If the key lock mode is set to "Password", you are asked to input your password.
Enter the password, then press the  key.



Notice

The default value for the password is "0000". You can change the password freely.

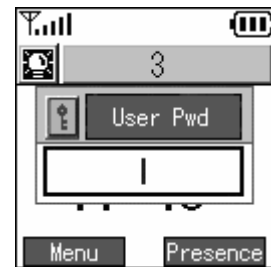

2

The phone goes into key lock mode.

When the phone goes into key lock mode, the key lock mode icon is displayed on the screen.



3 To unlock the keylock, hold down the  key again for at least one second.

If the key lock mode is set to "Password", you are asked to input your password.

If the key lock mode is set to "No password", you are not asked to input a password.

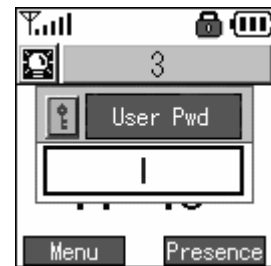

 **Notice**

When any key is pressed with the keys locked (with key lock mode and "password" selected), the password input screen is displayed.

When you input the correct password, the keylock is temporarily released and button operations become possible.

After the end of the button operations, the display returns to the standby screen and the keys are locked again.

Displays the setting menu.

1

In Standby, press the  key to select the menu.

Select "5. Setup" using the ▲▼ keys of the  key, then press the  key.



2

Displays the setup menu.

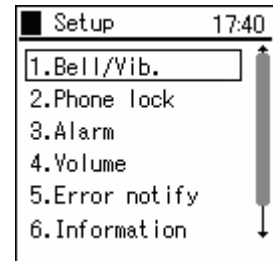









Password/lock mode selection

Changing the keylock password and configuring settings for keylock operations.

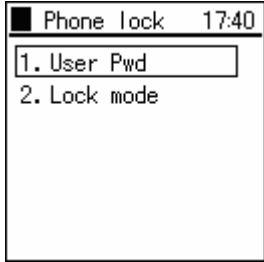

Notice

You can prevent unauthorized access by a third party by using a password to disable button operations on this product.

<p>1</p>	<p>To change the keylock password, from the setting menu, select "2. Phone lock" using the ▲▼ keys of the  key, then press the  key.</p>	
<p>2</p>	<p>From the phone lock menu select "1. User Pwd" using the ▲▼ keys of the  key, then press the  key.</p>	
<p>3</p>	<p>When you select "1. Password", the system asks for the current password. Please enter the correct password.</p> <p> The default value for the keylock password is "0000". If you input the wrong password, the message "input the correct password" is displayed asking you to input the correct password again. If you forget the password, you may not be able to set or release the keylock. (This depends on the lock mode setting.)</p>	
<p>4</p>	<p>When you input the correct password, the system asks you to input the new password. The password is a number up to four digits long.</p>	

Password/lock mode selection

- 5 For verification, the system asks you to input the new password a second time.

When you input the password, a dialog like that on the right is displayed for a few seconds.

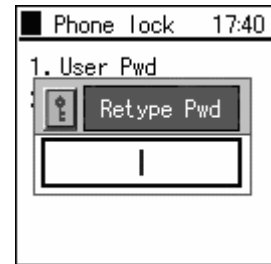

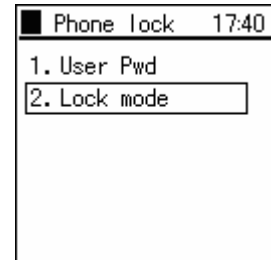

- 6 To check the keylock mode setting, select "2. Lock mode".

Select from "Password" or "No Password" using the ◀▶ Keys of the  key. If you select "Password", you are asked to input a password for setting and releasing the keylock. If you specify "No password", the system does not ask you to input a password.





Setting the ringer/vibration type. You can switch the ringer/ mode/ LED according to the incoming telephone number.

1 From the settings menu,

Select "1. Bell/Vib." using the ▲▼ keys of the  key, then press the  key.



2 You can set the mode separately for internal lines and external lines. You can make two settings for internal lines and two for external lines.

Select setting using the ▲▼ keys of the  key, then press the  key.

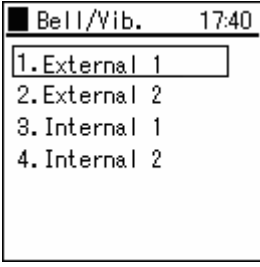

3 Displays configuration information.

- Ring Type
- Mode
- LED

To change a setting, from the detailed information display screen, press the  key, select "Edit", and select the value.

There are 16 ring types. (Bell 1 ~ Bell16)

There are four modes.







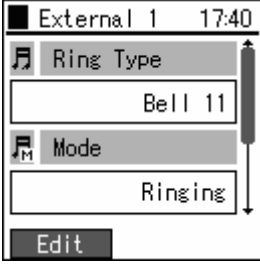

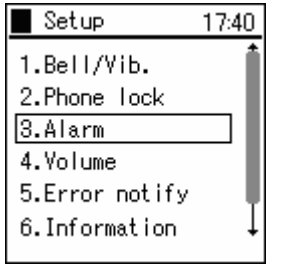

	Ring	Vibration	Ring+Vib	LED
Ringer	Yes	×	Yes	×
Vibrator	×	Yes	Yes	×

There are three LEDs. (RED, BLUE, Off)

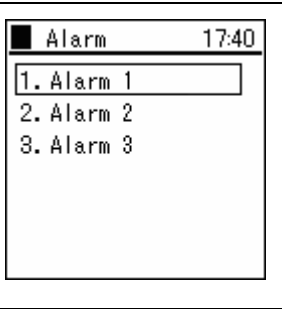
Finally, save with the  key.



Setting the alarm function

<p>1</p>	<p>To change the alarm function settings, from the setting menu,</p> <p>Select "3. Alarm" using the ▲▼ keys of the  key, then press the  key.</p>	
<p>2</p>	<p>Up to 3 alarm settings can be registered..</p> <p>Select "1. Alarm 1", "2. Alarm 2", or "3. Alarm 3" using the ▲▼ keys of the  key, then press the  key.</p>	
<p>3</p>	<p>Alarm setting information is displayed.</p> <ul style="list-style-type: none"> • Setup • Time • Ring • Repeat <p>To change a setting, Using the  key, select "Edit."</p> <p>For the setup, select "On" or "Off".</p> <p> Notice If you select "Off", the setting can be saved, but the alarm does not operate.</p> <p>Enter the alarm time.</p> <p>For "Ring", select from "Bell 1" through "Bell 5", "Vib.", or "Silent".</p> <p>For frequency, select from "Once", "Everyday", "Mon-Fri", or "Mon-Sat".</p> <p>Finally, save with the  key.</p>	 

Volume adjustment

Adjusting the ringer volume, handset volume, and button confirmation beep volume

1 From the settings menu,

Select "4. Volume" using the ▲▼ keys of the  key,
then press the  key.

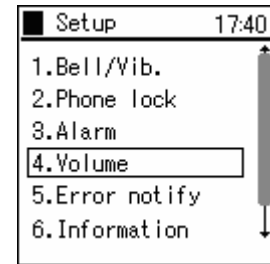

2 Displays configuration information.

- Ring Vol
- Handset Vol
- Notify Vol
- Key Tone Vol
- Headset Vol

Select the volume to be changed with the ▲▼ keys of the  key

Adjust the volume with the ◀▶ keys of the  key.

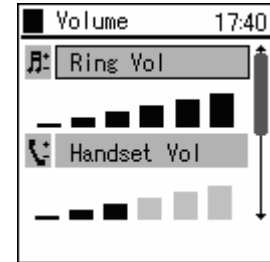

Finally, save with the  key.



Setting the Error notification

1

From the settings menu,

Select "5. Error notify" using the ▲▼ keys of the  key, then press the  key.

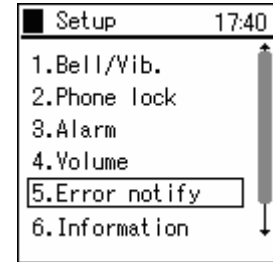



Service LED

Setting the Service LED

1

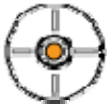
From the Error notify menu,

Select "1. Service LED", using the ▲▼ keys of the  key, then press the  key.

Displays configuration information.

- Use LED
- Mode
- Interval

To change a setting, select "edit" using the  key.

For Service LED, select "Enabled" or "Disabled".

For the mode, select "LED" or "LED+Beep".

For the interval, specify a number from 2 to 30.

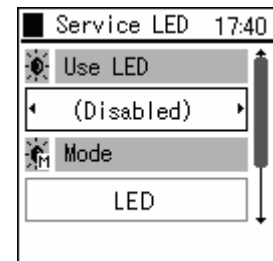
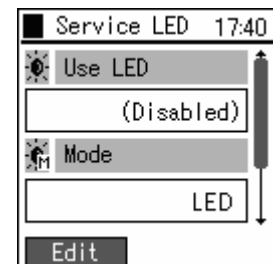
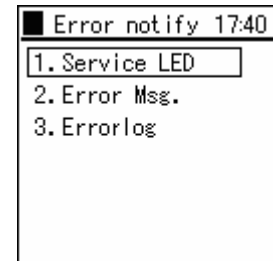

Finally, save with the  key.





Error message

Setting the error messages

1 From the Error notify menu,

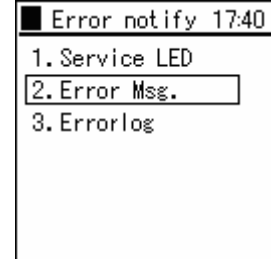
Select "2. Error Msg.", using the ▲▼ keys of the  key, then press the  key.





Select "On" or "Off" using the ◀▶ keys of the  key, then confirm with the  key.



Error log

The contents of the error log can be confirmed.

1 From the Error notify menu,

Select "3. Error log", using the ▲▼ keys of the  key, then press the  key.

The history of the error messages is displayed.

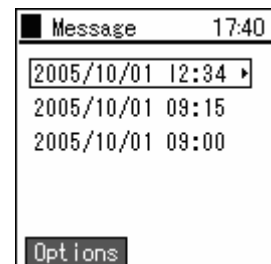
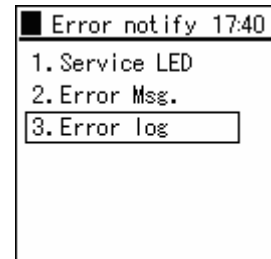



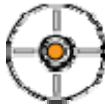

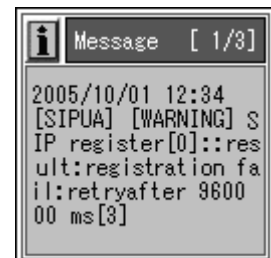
2 When the error message is selected from the list the detailed contents of the error are displayed.

Use the ◀▶ keys of the  key to switch through the detailed contents.



5

To delete an error message select "edit" using the  key,
Select "1. Delete all" then press the  key.

KeySelect "Yes" using the  keys of the  key,
then press the  key.

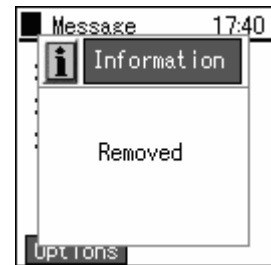
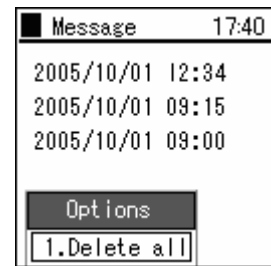

All error messages are deleted.



Information on the network can be checked.

1

From the settings menu,

Select "6. Information" using the ▲▼ keys of the  key, then confirm with the  key.

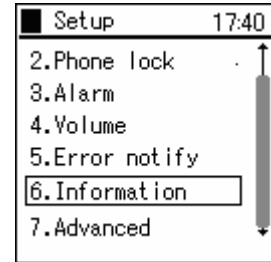

TCP/IP

You can check the TCP/IP contents.

1

From the information display menu, select "1. TCP/IP" using the ▲▼ keys of the  key,

then confirm with the  key..

The information below is displayed.

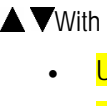
▲▼With the  key, scroll and check.

- Use DHCP
- IP address
- Netmask
- Gateway
- DNS1
- DNS2



Notice

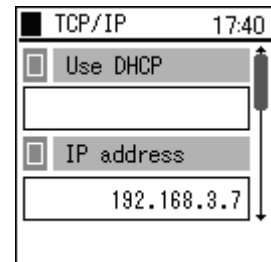
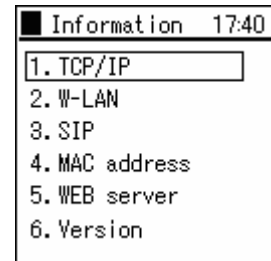

If the wireless network can not be connected to, "No network connection" is displayed.



Wireless networking

You can check the wireless contents.

1

Select "2. Wireless LAN" using the ▲▼ keys of the  key, then confirm with the  key.

The information below is displayed.

With the ▲▼ keys, scroll and confirm.

- CurrentNetwork
- SSID
- Signal (dBm)
- Mode
- Channel
- MAC address
- Beacon Intvl
- Security



Notice

If the wireless network can not be connected to, "No network connection" is displayed.

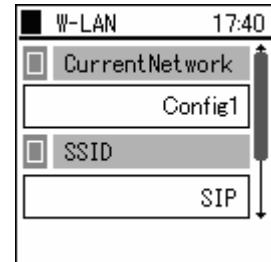
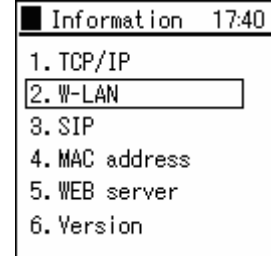

SIP

The contents of the SIP can be checked.

1

Select "3. SIP", using the ▲▼ keys of the  key, then confirm with the  key.

The information below is displayed.

With the ▲▼ keys, scroll and confirm.

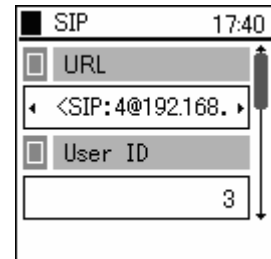
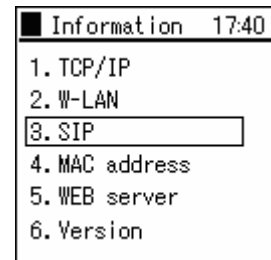

- URL
- User ID
- Proxy
- Register
- Outbound proxy



MAC address value

You can check the contents of the MAC address.

1

Select "4. MAC address" using the ▲▼ keys of the  key, then confirm with the  key.

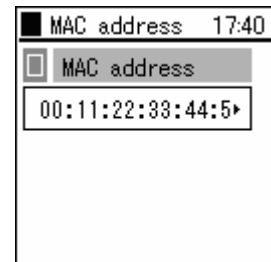
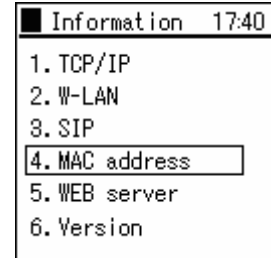

The MAC address for this product is displayed.



Web server

You can check the Web server contents.

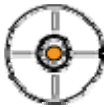
1

Select "5. Web server" using the ▲▼ keys of the  key, then confirm with the  key.

The following information is displayed.

- WEB server
- URL

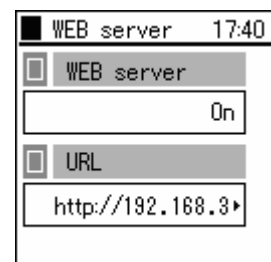

Version

You can check the version.

1

Select "6. Version" using the ▲▼ keys of the  key, then confirm with the  key.

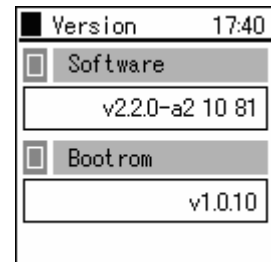

The following information is displayed.

- Software version.
- Boot ROM version



Perform settings for this product

1 From the settings menu,

Select "7. Advanced" using the ▲▼ keys of the  key, then press the  key.





Time

Set the clock



1 From the equipment settings menu,

Select "1. Clock" using the ▲▼ keys of the  key, then press the  key.



2 To set the date and time, from the clock menu select "1. Current time" using the ▲▼ keys of the  key, then confirm with the  key.

The date and time is displayed.

To change a setting, select "edit" using the  key, Input the date and time, save with the  key.

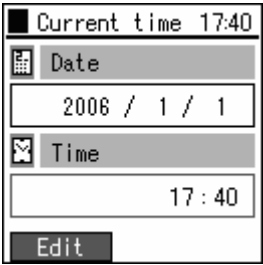



 **Notice**

Input the time in the 24-hour system regardless of the display format.

This product cannot store the time when the power is Off, but it has a function to automatically match the time with a time server.

3 To set the time server, from the clock menu,

Select "2. Time server" using the ▲▼ keys of the  key, then confirm with the  key.

This command displays the setting contents.

To change a setting, select "edit" using the  key



For "Auto time", select "Enabled" or "Disabled".

For NTP server1 and NTP server2, enter the IP address of the NTP server used.

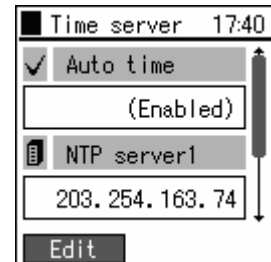
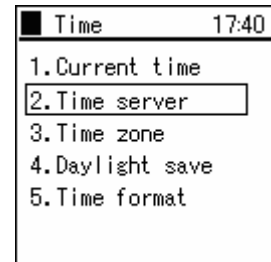
Finally, save with the  key.



4 To set the time zone from the clock menu,

Select "3. Time zone" using the ▲▼ keys of the  key, then confirm with the  key..

select the time offset value, then finally save with the  key.



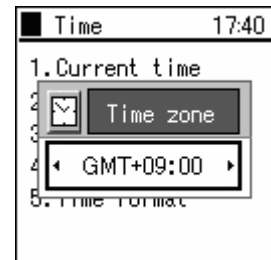
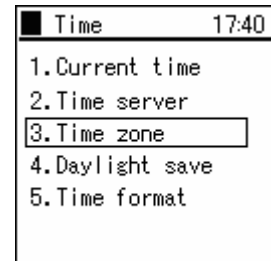

Notice

For use in Japan, set to GMT+09:00.



4 To set daylight saving time, from the clock menu,

Select "4. Daylight save" using the ▲▼ keys of the  key, then confirm with the  key.

The setting details are displayed.

To change a setting, select "edit" using the  key.



For Daylight saving time, select "Enabled" or "Disabled".

Enter the daylight saving time start date, start time, end date, and end time.

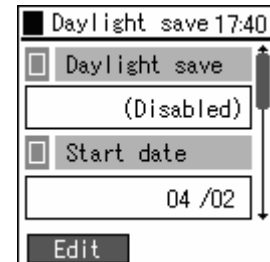
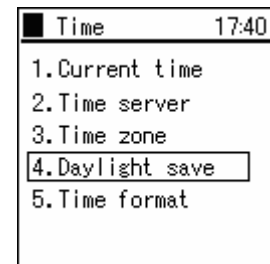
Finally, save with the  key.



5 To set the display format for the standby screen clock, from the clock menu,

Select "5. Time format" using the ▲▼ keys of the  key, then press the  key.

This command displays the setting contents.

To change a setting, select "edit" using the  key.

Date format: Select the display format for the date.

"2005/04/25 Mon"
 "05/04/25 Mon"
 "04/25/2005 Mon"
 "04/25/05 Mon"
 "25 Apr ,05"



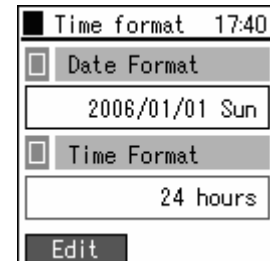
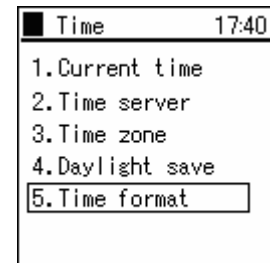

Time format: Select "24 hours" or "12 hours".

Finally, save with the  key.





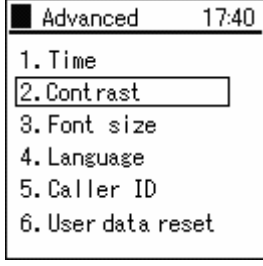
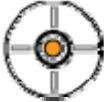

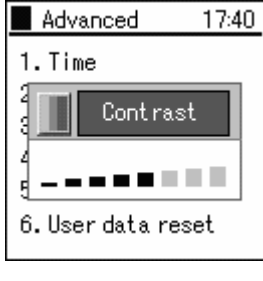
Contrast

Setting the display contrast

- | | | |
|----------|--|---|
| <p>1</p> | <p>From the equipment settings menu,</p> <p>Select "2. Contrast" using the ▲▼ keys of the  key, then press the  key.</p> |  |
| <p>2</p> | <p>Adjust the contrast using the ◀▶ keys of the  key, then confirm with the  key.</p> |  |

Font size

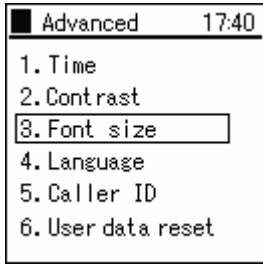
Setting the font size for when a telephone number is input during standby

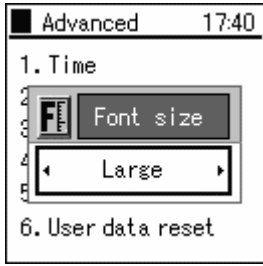
- | | | |
|----------|--|---|
| <p>1</p> | <p>From the equipment settings menu,</p> <p>Select "3. Font size" using the ▲▼ keys of the  key, then confirm with the  key.</p> |  |
| <p>2</p> | <p>Select "Large" or "Normal" using the ◀▶ keys of the  key, then confirm with the  key.</p> |  |

Language setting

Settings for the language display

1 From the equipment settings menu,

Select "4. Language setting" using the ▲▼ keys of the



key,

then confirm with the  key.

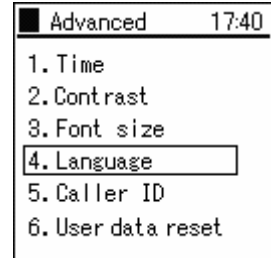

2

Select "Japanese" or "English" using the ◀▶ keys of the











key,

then confirm with the  key.



Deleting user data

This deletes all the user data (contact list, outgoing call log, and incoming call log).

1	From the equipment settings menu, Select "6. User data reset" using the ▲▼ keys of the  key, then press the  key.	
2	A confirmation message is displayed. Select "Yes" or "No" using the ◀▶ keys of the  key, then confirm with the  key.	
3	If you select "Yes", the user data is deleted. The "Removed" message is displayed and the display returns to the equipment setting menu.	 





Chapter 7 Maintenance



You can check the network settings.







1

On Standby, press the  key to select the menu.

Select "6. Network", using the ▲▼ keys of the  key, then confirm with the  key.

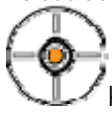

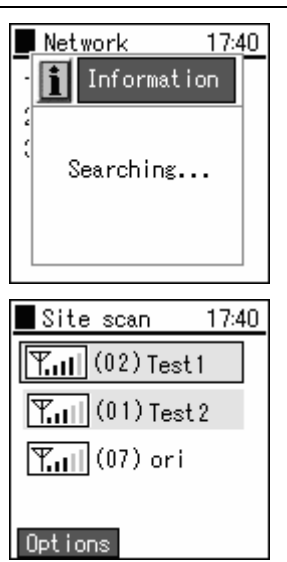
Information on signals detected can be displayed.

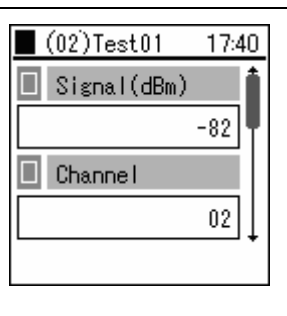
<p>1</p>	<p>From the maintenance menu,</p> <p>Select "1. Network search", using the ▲▼ keys of the  key, then confirm with the  key.</p>	
<p>2</p>	<p>A message is displayed during the search.</p> <p>The SSID of the detected access points are displayed after several seconds. To see detailed information, select the SSID and press the ▲▼ keys of the  key, then press the  key.</p> <p> Notice</p> <p>Access points configured to deny ANY connection are not displayed in the table of detected results. If the detected access point is encrypted, the SSID is screened and displayed. In addition, at most 20 access points can be displayed.</p>	
<p>3</p>	<p>The following information is displayed.</p> <ul style="list-style-type: none"> • Signal (dBm) • Channel • Security • MAC address (MAC address of the access point) • Mode • Beacon Interval <p>Press the  key to return to the SSID table.</p>	

4

To update the network search information press the  key and select "Submenu".

Select "1. Refresh", then press the  key.

The network search starts again.

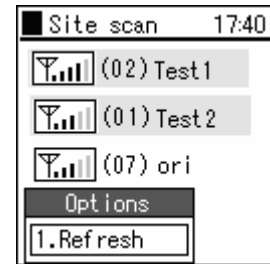

A ping can be sent for any IP address.

1

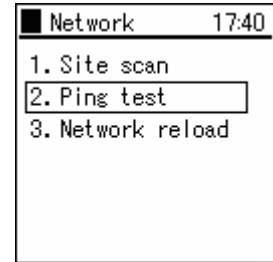

From the maintenance menu,

Select "2. Ping test" using the ▲▼ keys of the  key, then press the  key.

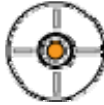

Manual

1

From the Ping test menu select "1. Manual" using the ▲▼ keys of the  key, then confirm with the  key.

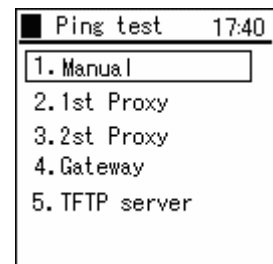

2

Enter the IP address for ping and press the  key to start the ping.

recv: Displays the ping response.
The following numbers indicate the response time (sec).

time out: Indicates there was no response to the ping.

To end ping, press the  key or  key.

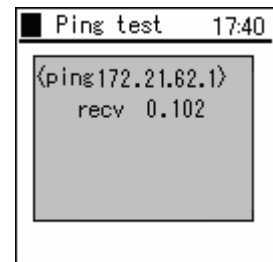
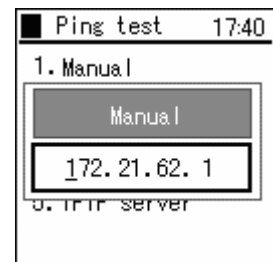

1st Proxy Server

1 From the Ping test menu

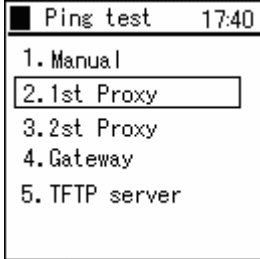

Select the "1st Proxy" server using the ▲▼ keys of the  key, then confirm with the  key.



2 Execute a ping to the 1st proxy server.

recv: Displays the ping response.
The following numbers indicate the response time (sec).

time out: Indicates there was no response to the ping.

To end ping, press the  key or  key.





3 If the 1st Proxy server is not configured, the message in the diagram on the right is displayed.



2nd Proxy Server

1 From the Ping test menu

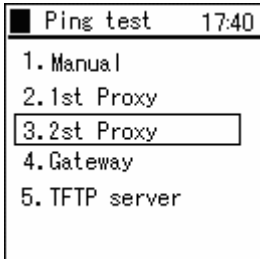

Select "3. 2nd Proxy" server using the ▲▼ keys of the  key, then confirm with the  key.



2 Execute a ping to the 2nd proxy server.

recv: Displays the ping response.
The following numbers indicate the response time (sec).

time out: Indicates there was no response to the ping.

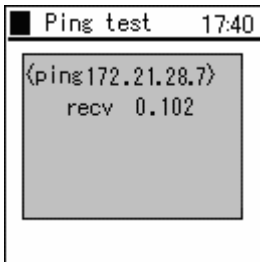

To end ping, press the  key or  key.



- 3 If the 2nd Proxy server is not configured, the message as shown in the diagram on the right is displayed.

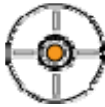

Default Gateway

- 1 From the Ping test menu
- Select "4. Gateway" using the ▲▼ keys of the  key, then confirm with the  key.

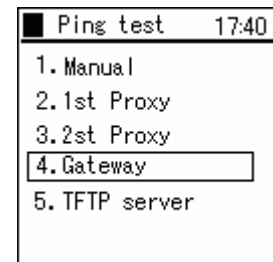

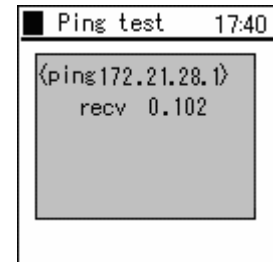

- 2 Execute a ping to the default gateway.
- recv:** Displays the ping response.
The following numbers indicate the response time (sec).
- time out:** Indicates there was no response to the ping.

To end ping, press the  key or  key.

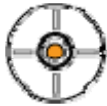

TFTP Server

- 1 From the Ping test menu
- Select "5. TFTP Server" using the ▲▼ keys of the  key, then confirm with the  key.

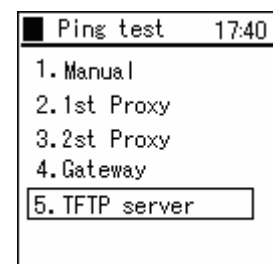





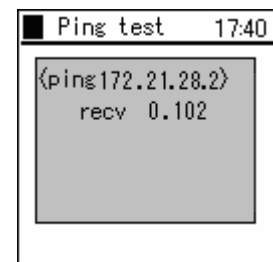



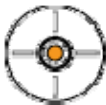

- 2 Execute a ping to the TFTP server.
- recv:** Displays the ping response.
The following numbers indicate the response time (sec).
- time out:** Indicates there was no response to the ping.

To end ping, press the  key or  key.



Network reload.

<p>1</p>	<p>From the maintenance menu,</p> <p>Select "3. Network reload" using the ▲▼ keys of the  key, then confirm with the  key.</p>	
<p>2</p>	<p>Select "Restart" or "Deactivate" using the ▲▼ keys of the  key, then confirm with the  key.</p>	
<p>3</p>	<p>In Standby, press the ▲ key of the  key to reconnect the network.</p>	
<p>4</p>	<p>Select "Restart" or "Deactivate" using the ◀▶ keys of the  key, then confirm with the  key.</p>	

Chapter 8 Web settings

Overview

The WirelessIP 5000 is able to be configured via the Internet. The WirelessIP 5000 Web settings can configure detailed settings that cannot be configured from the device itself.



Notice

The Web server for this device needs to be configured to "Enabled" when using the Web settings. The recommended browser is IE 5.0 or later.

When setting via TELNET:

Firstly, prepare a PC to be used to configure the WirelessIP 5000.

Next, configure the network to connect the PC to the WirelessIP 5000.

Start the browser from the PC to start the WirelessIP 5000 Web settings, <http://<host>:and access <port>/> Enter the IP address or host name for the device into <host> and enter the port number into <port>. (the port number is 8080 and cannot be omitted).

Access restrictions

The authentication screen for logging in to the WirelessIP 5000 web settings is displayed. Input the username and password that are set in the WirelessIP 5000 phone and log in.

	General User
Username	User (default)
Password	0000 (default)
Authority	<ul style="list-style-type: none">▪ Browse Basic Information▪ Edit Phonebook▪ Change User Password

(Note) The same user cannot simultaneously log in from multiple browsers (clients). General user and admin user are allowed to log in simultaneously.

Only browsing of basic information, editing the phonebook, and editing of the user password are permitted.

Main

The basic information regarding the phone such as its software version and TCP/IP settings is displayed.

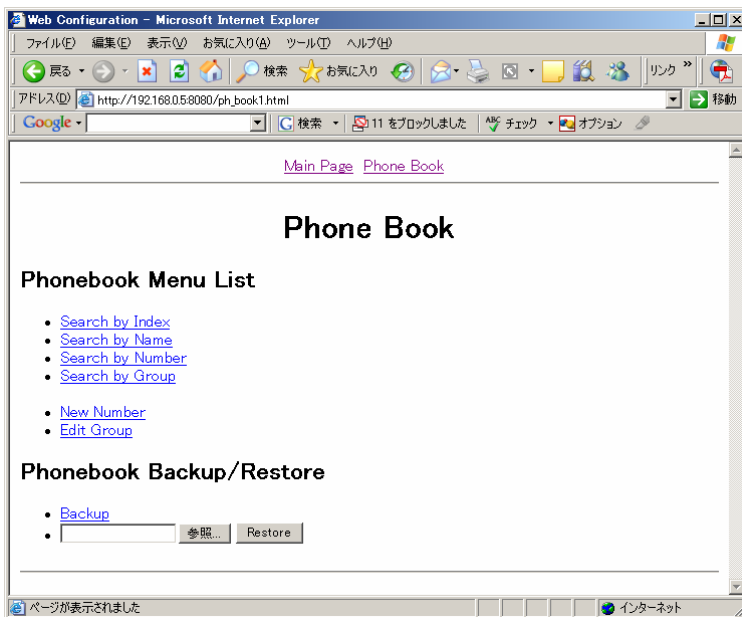

[Display Items]

- Model: displays model name
- Software version: displays software version of the WirelessIP 5000
- IP address: displays IP address of the phone
- Net mask: displays net mask of the phone
- Default gateway: displays default gateway of the phone
- MAC address: displays MAC address of the phone

Phone book

Searches/configures/deletes the phone book data in the WirelessIP5000.

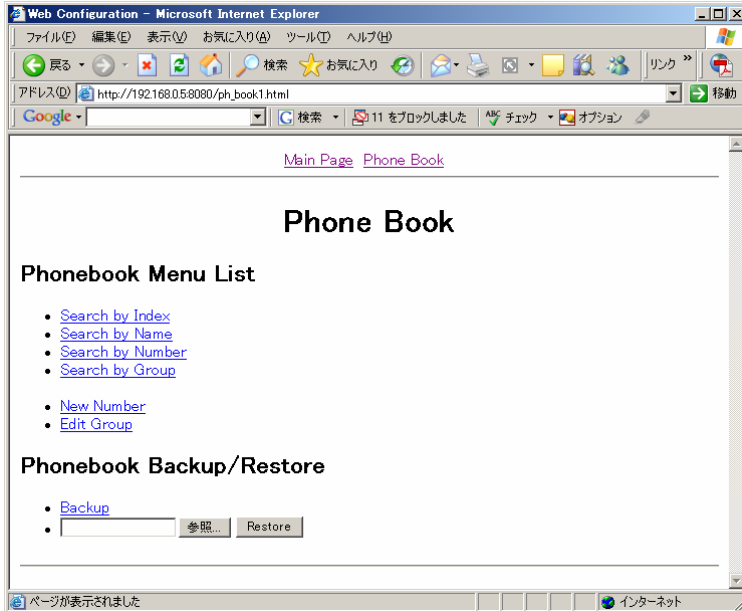

■ Phonebook Menu List

Search by Index: Searches/edits/deletes by speed dial number.

Name Search: Searches/edits/deletes by name.

Phone Number Search: Searches/edits/deletes by telephone number.

Group Search: Searches/edits/deletes by group.

Registration of a New Phone Number: Registers a new number to the phone book data.

Group Registration: Searches/edits/deletes groups.

● Searches/Edits/Deletes the Phone book

1. Select the search method from the Phone book menu.

(Search by Index, Name, Phone Number, Group)

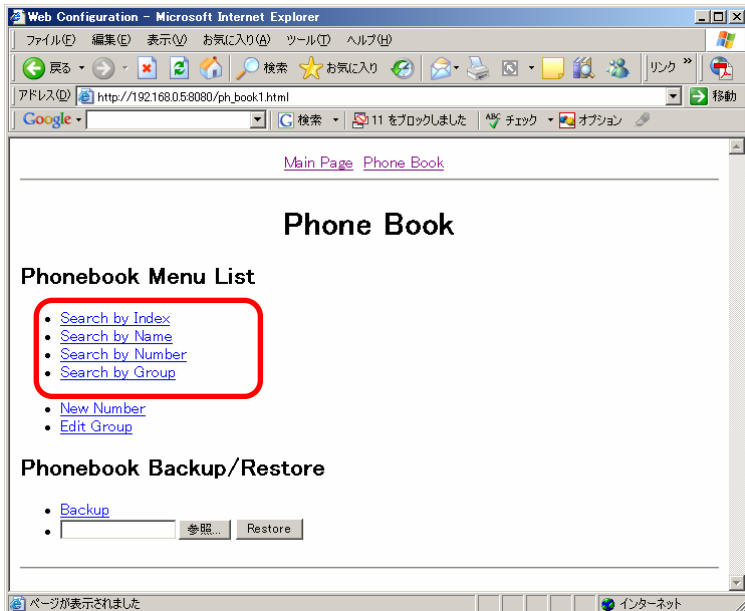

2. Enter search information and click the "Search" button. If no search information is entered and the "Search" button is pressed, the entire phonebook displays.

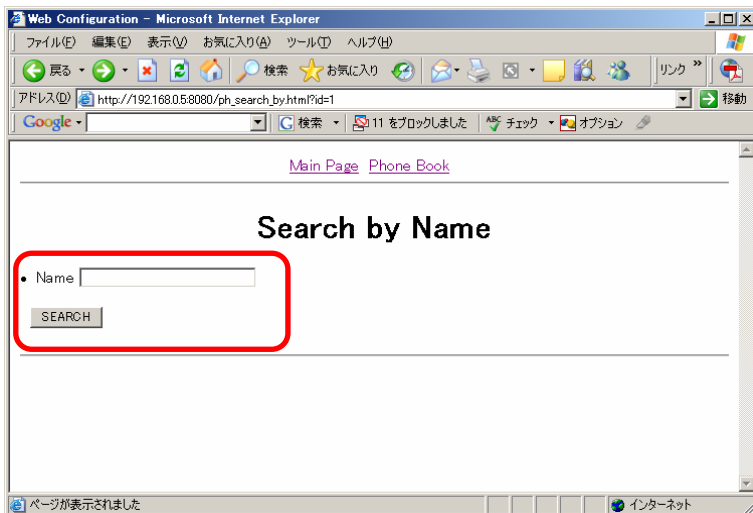

3. The Phone book data matching the search information is displayed.

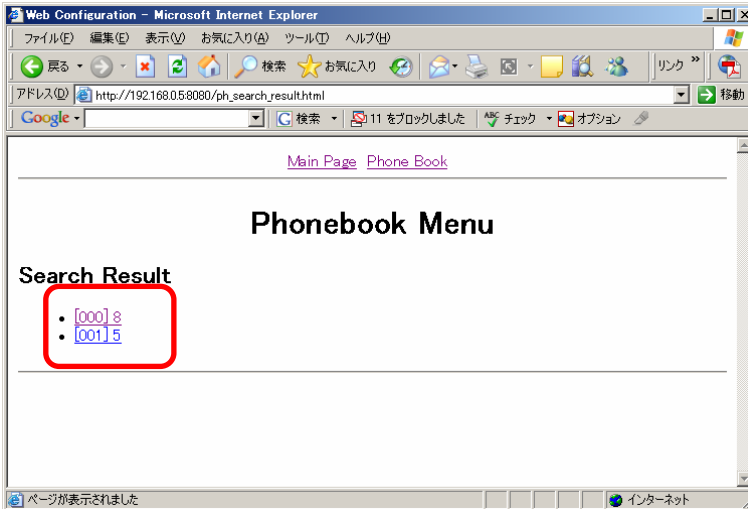

4. When the displayed phone book data is selected it can be edited/deleted.

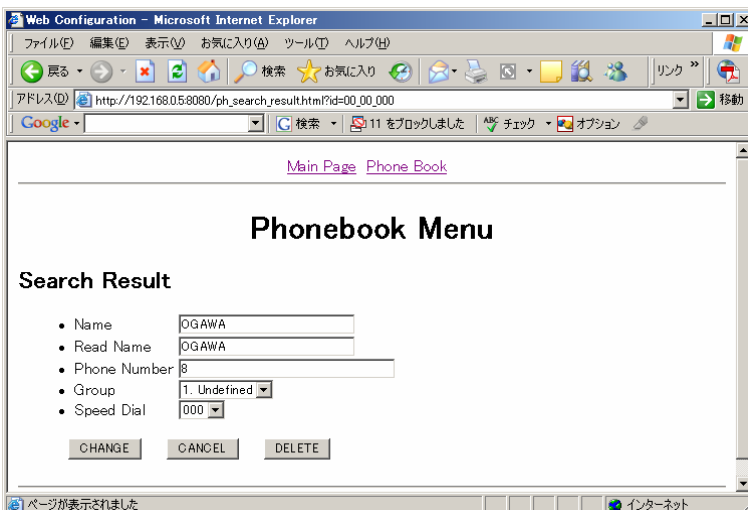

● Registration of New Phone Numbers

1. Select registration of new phone numbers from the phonebook menu.

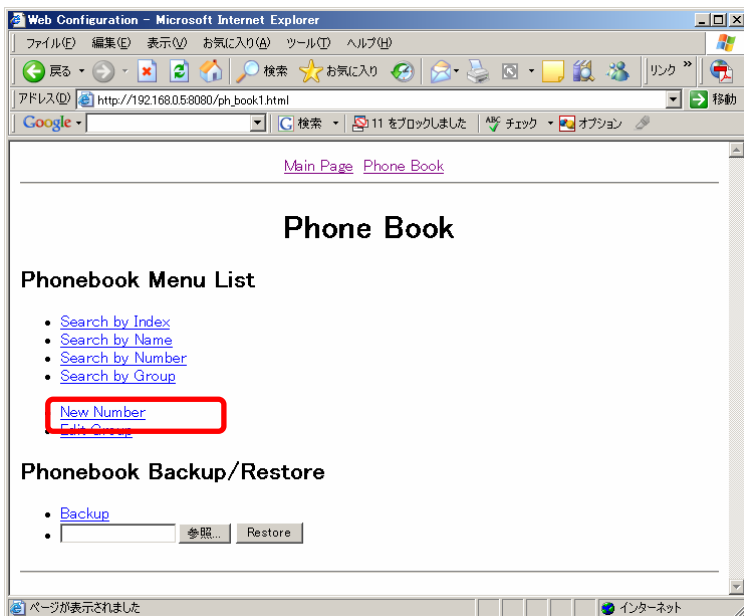

2. Enter the name, phone number, speed dial number, and group.

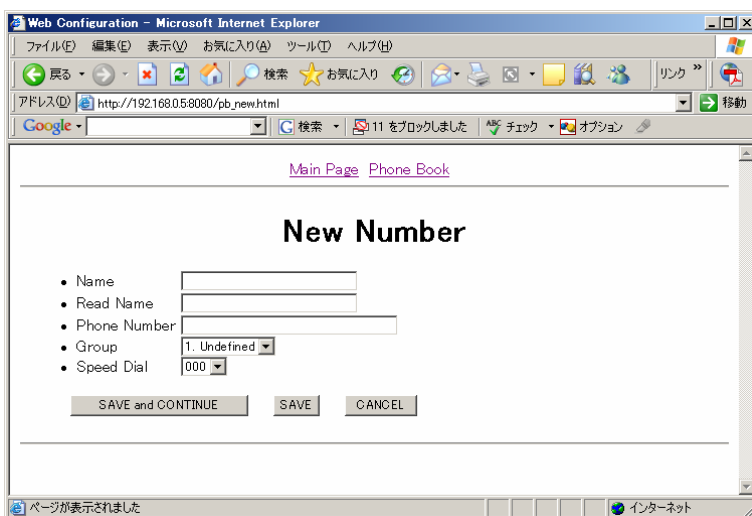

3. Click the "Save/Continue" button to continue to create a new phone book entry.

4. Click the "Save" button to register it to the phone book and to return to the phone book menu.

Edit Group

1. Select Edit Group from the phone book.

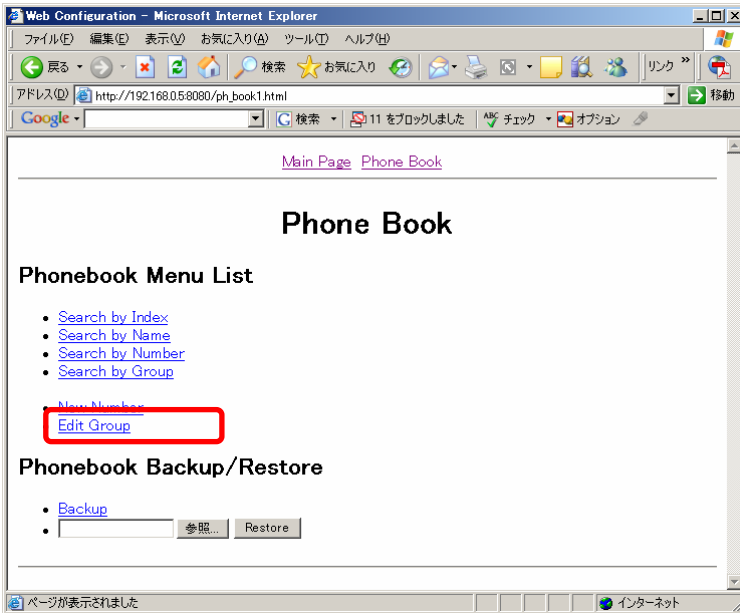

2. When adding a group, enter the group name into the new group, and click the "Save" button.

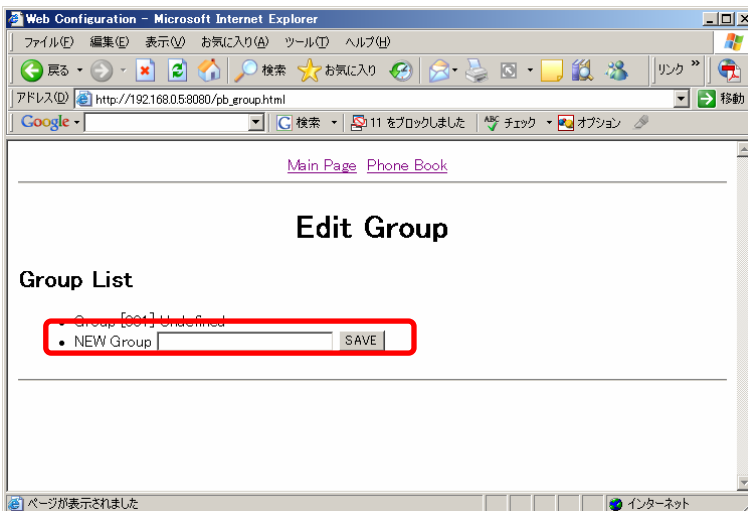

3. Click the group name to edit or delete the group.

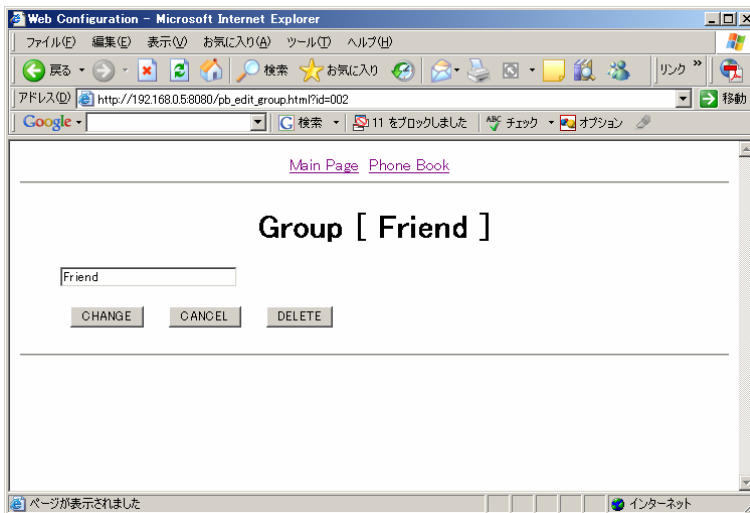
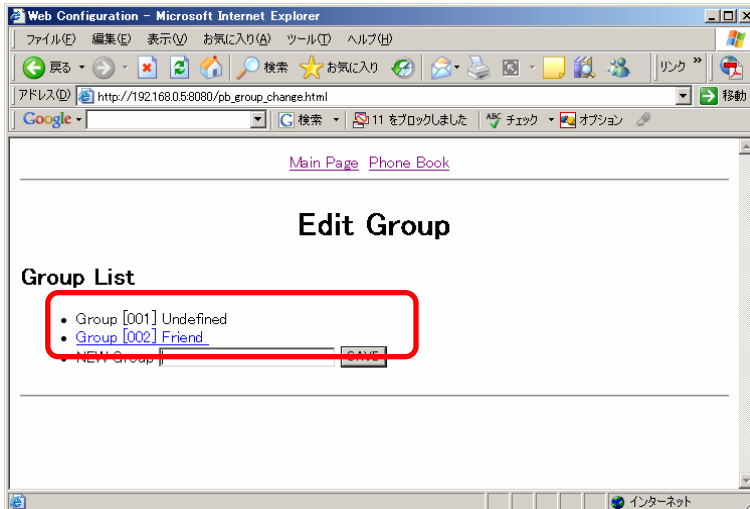

Backing up/Restoring the Phonebook

Backup: Backs up the phonebook data.

Restore: Restores the phonebook data.

Backup

1. Select backup from the phone book menu.

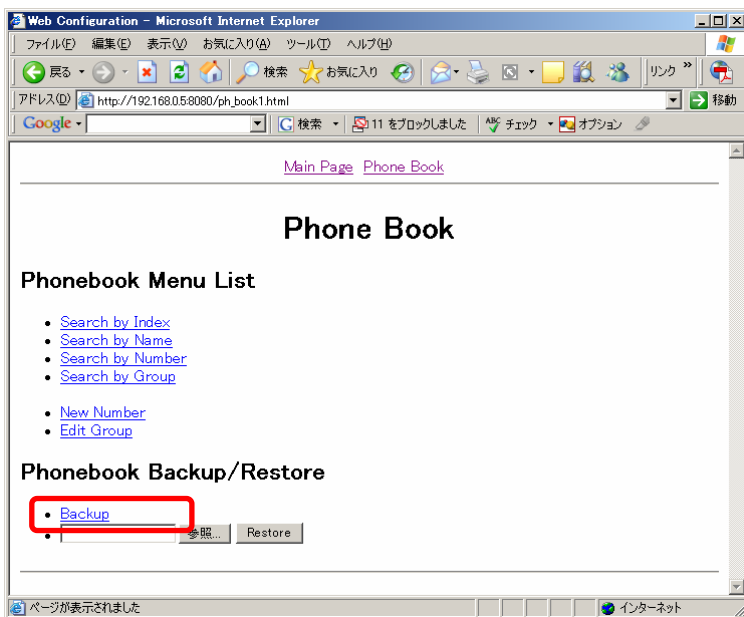

2. When vCard or CSV format is selected, the phone book data can be downloaded in the selected format.

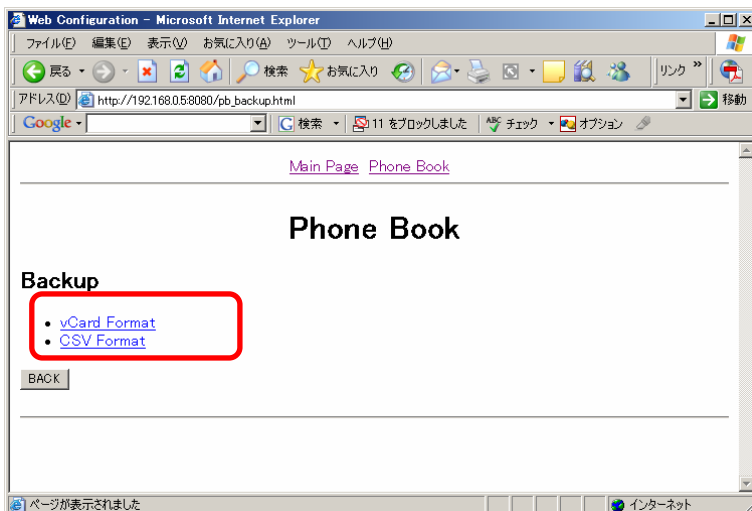

● Restore

1. Click the "Browse" button from the phone book menu and select the backup file.

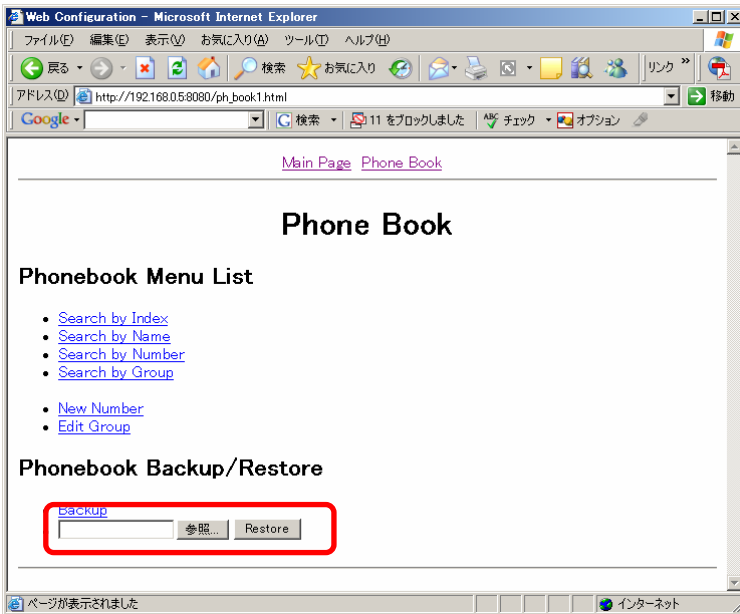

2. Click the "Restore" button to restore the phonebook.

Changing the Password

Changes the user password for the WirelessIP 5000.

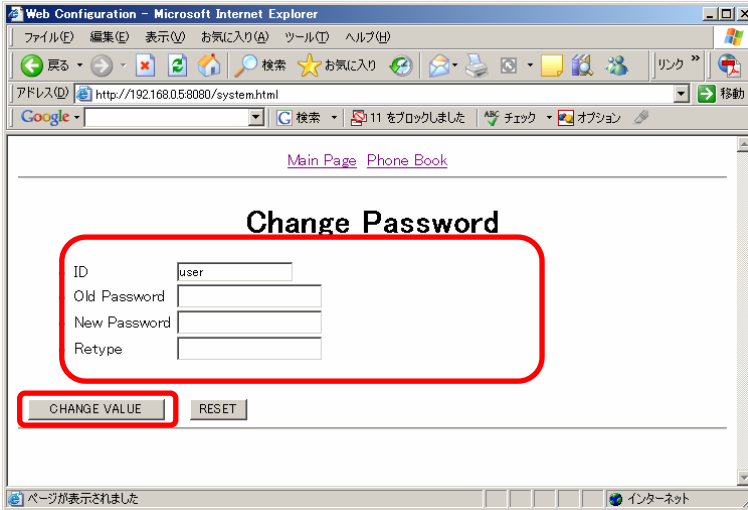

Enter the username (user) in the ID field.

Enter the old password.

Enter the new password.

Re-enter the new password (for confirmation).

Click the "CHANGE VALUE" button.

* Click the "RESET" button to reset the entered information.

* Select 4 digits as the password.

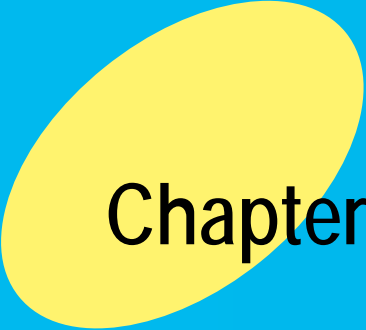

Chapter 9 Appendix

Phenomena	Response
Does not start.	The battery pack may be dead. If the battery pack is dead, the device will not start and the LED will not light up. Restart it again after recharging the battery using the AC adapter.
Cannot operate the keys and the displayed information does not update.	Remove the battery pack and then reconnect it.
It is hard to see the display	Adjust the contrast.
Vertical lines appear on the display.	If the device has not been used in a while and the battery pack has been removed incorrectly, vertical lines may appear on the display. Remove the battery pack and then reconnect it.
Communication is bad or the phone suddenly disconnects.	It is possible that you are too far from the access point, the signal is being weakened by an obstruction such as a wall, or there is electromagnetic interference. Confirm the reception level.
The standby time is different to that in the specifications.	The battery pack standby time may differ according to the configuration or settings of the access point.
The device heats up.	When the device is located outside the range of the access point, the device may consume power. This device may become somewhat warm.
The device heats up when communicating or recharging.	The device may become warm during calls or recharging. Continue to use as normal as this is not unusual.
The volume is low.	Adjust the volume.
After turning the power on, the time reverts to the default value.	Although this device cannot retain the time when the power is turned off, there is a function that automatically sets the time by matching the time information on the NTP server.
The battery pack becomes unable to be used.	If the device will not be used for more than a month, remove the battery from the unit. The battery pack may become unusable due to self-discharge. Store the battery pack at less than 20°C in a low-humidity environment that is clean and free of dust.
The sound is interrupted when backing up or restoring phonebook data from a WEB server during communication.	Sound may be interrupted when backing up or restoring phonebook data from a WEB server during communication. Continue to use as normal as this is not unusual.

Number pad equivalence table

■ Number Input Mode

■ Character Input Mode (similar to lower case)

Key	Character assignments	Key	Character assignments
1	1	1	. (dot) @
2	2	2	A B C
3	3	3	D E F
4	4	4	G H I
5	5	5	J K L
6	6	6	M N O
7	7	7	P Q R S
8	8	8	T U V
9	9	9	W X Y Z
*	* . (dot)	*	* . (dot) -
0	0	0	Blank
#	# @	#	# @ _

■ Hiragana Input Mode

■ Katakana Input Mode

Key	Character assignments	Key	Character assignments
1	あいうえおあいうえお	1	アイウエオアイウエオ
2	かきくけこ	2	カキクケコ
3	さしすせそ	3	サシスセソ
4	たちつてとつ	4	タチツテトツ
5	なにぬねの	5	ナニヌネノ
6	はひふへほ	6	ハヒフヘホ
7	まみむめも	7	マミムメモ
8	やゆよやゆよ	8	ヤユヨヤユヨ
9	らりるれろ	9	ラリルレロ
*	Changed Voiced Consonant Marks	*	Changed Voiced Consonant Marks
0	わをんーわ	0	ワヲンー
#		#	

Character input method

1

On the input screen, use the  key to switch the input mode (hiragana, katakana, upper case/ lower case/ symbols/ numbers).
The mode switching depends on the item being input.

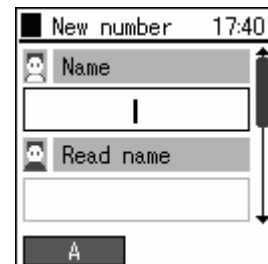

2

When selecting a symbol, select the type of symbol by using the dial pad.

Select the symbols using the dial pad.

 **Notice** Use the ▲▼ keys of the  key to switch pages. (16 pages in all)

Set the symbol by pressing the  key.

The selected symbol is entered.

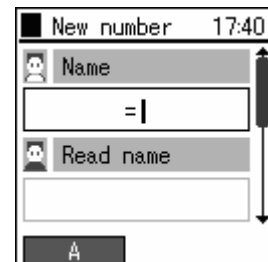
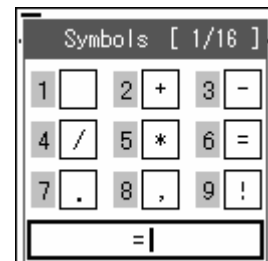
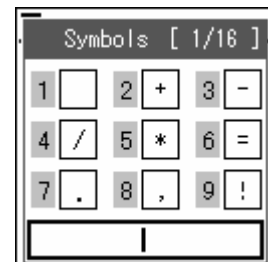
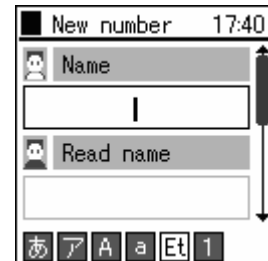

3 When selecting the hiragana, after entering

use the ▼ key of the  key to change the kanji.

Select the appropriate kanji using the ▲▼ keys and press the  key to confirm the character.

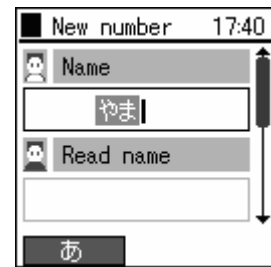

New number 17:40

Name

やま

Read name

あ



New number 17:40

Name

山

Read name

あ

4 To delete the entered character, press the  key.

If the  key is pressed for more than a second all characters are deleted.

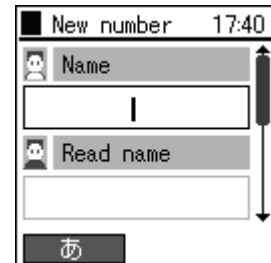

New number 17:40

Name

|

Read name

あ



This device uses the Omron Software's Japanese conversion software "Mini Wnn" to convert the Japanese.

Explanation of the Menu screen.

1 Menu numbers can be directly entered on the menu screen to move to a function, in

addition to using the  key.

For example, when the 5 key is pressed on the screen in the right diagram, it moves to the Setup Menu.

And when the  key is pressed, the device returns to the previous screen.

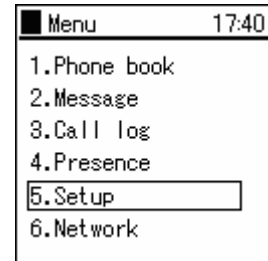
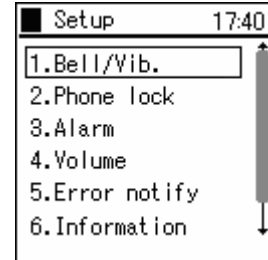
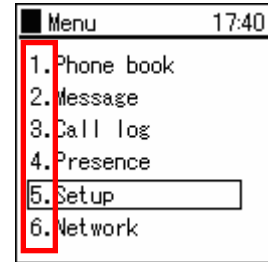

Notice

The menu contents change somewhat according to the connection device and the settings of this device.

Specifications

No.	Item		Specifications	
1	Main Unit	Physical dimensions	44(W)mm × 22(D)mm × 127(H)mm	
		Weight	Approx. 100g (including the battery pack)	
		Usage Environment	Temperature: 5-40°C; Humidity: 10-90%	
2	Wireless Radio	Standards	IEEE802.11b	
		Transmission method	DBPSK (1Mbps) DQPSK (2Mbps) CCK (5.5&11Mbps)	
		Frequency band	2.4GHz Band (2400-2497MHz)/1-14ch	
		Output power	10 mW/MHz max.	
		Data rate	1/2/5.5/11 Mbps	
3	Software	Audio encoding	G.711 A-Law/ μ -Law 64kbps G.729A 8kbps	
		Security	SSID WEP(64/128/256bit)	
4	Battery	Battery pack	Capacity	3.7V 1350mAh Li-ion
			Call time	Approx. 3 hours *1
			Standby Time	About 55 hours *3
			Battery charging time	About 3 hours

*1 The communication and standby times may fluctuate due to environment conditions, i.e. charge conditions, temperature, electromagnetic wave conditions, etc. and function settings.

* Do not use a supply voltage other than 100V AC when recharging.

* The appearance/specifications may change without notice.

LAN (Local Area Network)	Abbreviation for Local Area Network. Refers to a small scale computer network.
Beacon	This is a data packet periodically sent by the access point to simplify the connection with the wireless LAN client device.
Power save mode	There are two operating modes of the wireless client: power save mode and active mode. The power save mode intermittently places the device in sleep mode to save on power. The active mode always provides power to the communication circuit.
DTIM (Delivery Traffic Indication Message)	This is a message to a wireless client in power save mode that a packet is waiting to be transmitted. This packet is a message transmitted to stating that the device is in transmission standby. For example, if set to "2" , a beacon with DTIM and a beacon without are able to be mutually transmitted from the access point.

B

Beacon Interval..... 7-3
Button Confirmation Volume..... 6-10, 6-11

C

Call..... 2-3, 2-9, 2-10, 2-12, 2-13, 2-14, 2-15, 2-16
Call log..... 2-5, 2-6, 2-7, 2-8, 2-9, 3-7
Call waiting 2-18
Caller ID 2-12
Channel 7-3

D

Deleting user data 6-23
Disconnect..... 7-8
Display Format of the Clock 6-20

E

Encryption..... 7-3
English..... 6-21, 6-22
Edit Group 3-11, 3-12

H

Hold 2-17, 2-18, 2-19

I

Internal number:..... 2-3, 2-4
Internal Number Settings..... 6-21, 6-22
IP address 7-5

J

Japanese..... 6-21, 6-22

K

Key Lock Mode..... 6-3, 6-4, 6-7

M

MAC address value 7-3
Mode..... 7-3

N

N Network connections..... 7-8
Network search..... 7-3, 7-4
No alert 2-12, 2-13

O

Outgoing Calls 2-5, 2-6, 2-9, 2-13, 2-15, 6-23

P

Password..... 6-3, 6-4, 6-6, 6-7
Ping..... 7-5
Ping test 7-5

R

Received Calls..... 2-5, 2-6, 2-9, 2-13, 2-15, 6-23
Receiver Volume 6-10, 6-11
Receiving calls..... 2-4
Redial..... 2-9
Reinstallation 7-8
Ringer Volume 6-10, 6-11
Ringer/vibrator 6-8

S

Signal..... 7-3
Speed dial number..... 2-10, 2-16, 3-4, 3-6, 3-8, 3-10
SSID 7-3

T

Text input mode..... 9-3
Transfer 2-19, 2-20, 2-21
Transmission Mode 2-13, 2-15

U

USB cable 1-7, 1-8, 1-9

V

Version 6-17
Volume adjustment..... 6-9, 6-10

W

Wireless networking 3, 4, 1-2

NOTICE

This product is in accordance with the Japanese Foreign Exchange and Foreign Trade Law.

When you plan to export or take this product out to overseas, similar law(s) and/or regulation(s) applicable in your country may require approval or permission from a relative authority.

Our corporate homepage provides updated information and version upgrade services for each product. To use this product in the most appropriate manner it is recommended that this homepage is periodically visited.

Homepage: <http://www.wirelessip5000.com/>

TOSHIBA